

節亮康復產品有限公司產品手冊

Health Product

Your Smart Health Care Solution Partners
Health care product | Smart home care | Air purification

Traction Devices

27

Ziglite Smart Health Care Products Co., Ltd.





Z IGLITE[®]
HEALTHCARE



COMPANY PROFILE

公司簡介

Ziglite Smart Health Care Products Co., Ltd. Incorporated in 2018, we work with our partners to bring their products to the local market. Mainly engaged in the management of health care products, the main customers are hospitals and clinics, homes for the elderly and home patients.

We are committed to the development of excellent health care products, dedicated to the needs of a wide range of different customers, get the best care in the family treatment process, and greatly improve the effect of rehabilitation. Get the best care during the family treatment process and greatly improve the healing effect. We will provide quality products with stable quality and stable performance for customers.

We specialize in a wide range of products including: anti-virus and air freshening, incontinence care, mobility aids, decompression supplies, etc.

YOUR SMART HEALTH CARE
SOLUTION PARTNERS



公司於2018年成立，我們與合作夥伴一起把他們的產品推向本地市場。以經營康護用品為主，主要客戶為醫院及診所，安老院及家居病人等。

我們致力於發展卓越的康護醫療產品，竭誠照顧廣大不同客戶的需要，在家庭治療過程中得到最好的護理，大大提高康復治療效果。在家庭治療過程中得到最好的護理，大大提高康復治療效果。務求為客戶提供品質優越及性能穩定的醫療產品。

我們專營的產品種類繁多，包括：抗病毒及空氣清新，失禁護理，助行用品，減壓用品等。



A Cervical vertebra traction device

頸椎牽引



P2 JCG



P3 JCK



P4 JCL



P5 JAC



P6 JR



P7 JT



P8 JBD



P9 JDB



P10 JDS



P11 JED



P12 JBE

B Thoracic & lumbar traction device

胸&腰椎牽引



P14 JCH



P15 JCI



P16 JCJ



P17 KF



P18 JJ



P19 JK



P20 JI



P21 JBW



P22 JCX



P23 JCY



P24 JDY



P25 JFO



P26 JEH

C Cervical vertebra traction device

手臂&肩部支撐牽引



P28 JBA



P29 JFN



P30 JAE



P31 JAF



P32 JAG



P33 JD



P34 JE



P35 JV



P36 JDD



P37 JDR



P38 JEE



P39 JEQ



P40 JFD



P41 JFF



P42 JBB



P43 JBC

D Hand fixing supporter

手部固定支撐



P45 JAD



P46 JAO



P47 JAI



P48 JAJ



P49 JAK



P50 JAM



P51 SU



P52 SV



P53 JG



P54 JF



P55 JH



P56 KJ



P57 JL



P58 JBQ



P59 JBS



P60 JDE



P61 JDX



P62 JEA



P63 JEB



P64 JEC



P65 JEN



P66 JET



P67 JEV

E Lower limb traction device 下肢牽引



P69 JX



P70 JY



P71 JZ



P72 JAW



P73 JAX



P74 JAZ



P75 JBU



P76 JBV



P77 JBX



P78 JBK

C Foot fixing supporter

足部固定支撐



P80 JAN



P81 JU



P82 JDC



P83 JDQ



P84 JDZ



P85 JEW



P86 JDN



P87 JDO



P88 JEG



P89 JFL



P90 JDP



P91 JAH



P92 JAL



P93 JAY



P94 KD



P95 JBT



P96 JEX



P97 JFG



Cervical Vertebra Traction Device

頸椎牽引

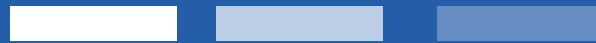

Adjustable Hot Compress Type Cervical Traction Device

可調節熱敷型頸椎牽引器

Model: JCG

Features:

- Adjustable cervical traction device, adjustable on both sides;
- Back hot compress physical therapy, double effect;
- Humanized lock neck design, fixed button;
- Adjustable lifting, ergonomic design;
- Indications: back pain, neck and shoulder pain, dizziness and headache, neck stiffness, muscle swelling, neck and shoulder disc protrusion, back column bending.
- 可調節頸托牽引器, 雙側升降旋鈕可調
- 後部熱敷理療, 雙重功效
- 人性化鎖頸設計、固定按扣
- 可調節升降, 人體工學設計
- 適應症: 腰酸背痛、頸肩酸痛、頭暈頭痛、脖子僵硬、肌肉酸脹、頸肩盤突出、背柱彎曲



Specifications

| | |
|--------------------------------|--|
| Product model 產品型號 | JCG |
| Product function 產品功能 | cervical traction stretch hot compress 頸椎牽引拉伸熱敷 |
| Product material 材質面料 | PU, cotton PU, 棉 |
| Rated voltage 額定電壓 | 5V |
| Power 功率 | 1W |
| Measuring time 加熱溫度 | 60°C |
| Temperature control range 溫控範圍 | 40-70°C |
| Body care area 身體護理部位 | neck brace 護頸 |
| Weight 重量 | 400g |
| Packing size 包裝尺寸 | 25x19.5x22cm |
| Package weight 包裝重量 | 6.5kg |



注意事項:

- ◆ 可調節頸托牽引器適用於一般的頸椎疾病, 特殊情況或診斷不明確的(例如腫瘤、頸部血管問題等), 應在醫生指導下進行頸部牽引。
- ◆ 牽引若造成患者症狀加重或感覺不適時, 應立即停止牽引, 改變牽引方式或在醫生指導下進行, 脊椎型頸椎病慎用。
- ◆ 體質弱, 有心、肺疾病, 心肺功能不全者, 頸部、下頷有感染病灶或腫塊者, 甲狀腺功能亢進、甲狀腺腫塊患者禁用。

Inflatable Cervical Traction Apparatus

充氣式頸椎牽引器

Model: JCK

Features:

- The neck brace is designed with a 20 degree forward tilt to fix the neck to a good cervical spine physiological curvature
- The longitudinal expansion of air can effectively traction cervical spine
- Manual inflation is used, and the traction force can vary from person to person
- The neck cushion is removable for easy cleaning;
- Can be used as a neck anchor
- Indications: back pain, neck and shoulder pain, dizziness and headache, neck stiffness, muscle swelling, neck and shoulder disc protrusion, back column bending.
- 頸託前傾20度設計,貼合頸椎生理曲度
- 空氣縱向膨脹可有效牽引頸椎
- 採用手動充氣,牽引力量可因人而異
- 頸部靠墊可拆卸方便清洗
- 可以當做頸部的固定器使用
- 適應症: 腰酸背痛、頸肩酸痛、頭暈頭痛、脖子僵硬、肌肉酸脹、頸肩盤突出、背柱彎曲



Specifications

| | |
|-------------------------------------|-------------------------------------|
| Product model 產品型號 | JCK |
| Product function 產品功能 | cervical traction stretch 頸椎牽引拉伸 |
| Product material 材質面料 | PU, cotton PU, 棉 |
| Neck circumference 頸圍 | 69-76cm |
| Accessories 配件 | hand pump 手打氣筒 |
| Size 尺寸 | 23*16*15cm |
| Inflatable expansion size 充氣展開尺寸 | 49*20cm |
| Weight 重量 | 410g |
| Packing size 包裝尺寸 | 240*185*180cm |
| Package weight 包裝重量 | 0.79kg |



注意事項:

- ◆ 適用於一般的頸椎疾病,特殊情況或診斷不明確的(例如腫瘤、頸部血管問題等),應在醫生指導下進行頸部牽引。
- ◆ 牽引若造成患者症狀加重或感覺不適時,應立即停止牽引,改變牽引方式或在醫生指導下進行,脊椎型頸椎病慎用。
- ◆ 體質弱,有心、肺疾病,頸部、下頷有感染病灶或腫塊者,甲狀腺功能亢進、甲狀腺腫塊患者禁用。

Hot Compress Type Cervical Traction Device

熱敷型頸椎牽引器

Model: JCL

Features:

- Adjustable cervical traction device, high, low, loose and tight can be adjusted;
- Can be used for electric heat therapy, with double effects;;
- Humanized lock neck design, fixed button;
- Adjustable lifting, ergonomic design;
- Indications: back pain, neck and shoulder pain, dizziness and headache, neck stiffness, muscle swelling, neck and shoulder disc protrusion, back column bending.
- 可調節頸托牽引器, 高、低、鬆、緊均可調節;
- 可以電熱療, 雙重功效;
- 人性化鎖頸設計、固定按扣;
- 可調節升降, 人體工學設計;
- 適應症: 腰酸背痛、頸肩酸痛、頭暈頭痛、脖子僵硬、肌肉酸脹、頸肩盤突出、背柱彎曲。



Specifications

| | |
|-----------------------|--|
| Product model 產品型號 | JCL |
| Product function 產品功能 | cervical traction stretch hot compress 頸椎牽引拉伸熱敷 |
| Product material 材質面料 | PP+PC+POM |
| Rated voltage 額定電壓 | 5V |
| Power supply 電源供應 | USB |
| Measuring time 加熱溫度 | 45°C/65°C |
| Accessories 配件 | 1.5m USB power cord 1.5米USB電源線 |
| Size 尺寸 | 23*17.8*19cm |
| Weight 重量 | 310g |
| Packing size 包裝尺寸 | 24*18.5*18cm |
| Package weight 包裝重量 | 0.65kg |



注意事項:

- ◆ 適用於一般的頸椎疾病, 特殊情況或診斷不明確的(例如腫瘤、頸部血管問題等), 應在醫生指導下進行頸部牽引。
- ◆ 牽引若造成患者症狀加重或感覺不適時, 應立即停止牽引, 改變牽引方式或在醫生指導下進行, 脊椎型頸椎病慎用。
- ◆ 體質弱, 有心、肺疾病, 頸部、下頷有感染病灶或腫塊者, 甲狀腺功能患者禁用。
- ◆ 使用時請注意溫度, 對熱敏感的人群請注意使用。

Adjustable cervical spine support Protector

可調式頸椎支撐護具

Model: JAC

Features:

- Adopting rigid porous polypropylene mechanism and padding design on the skin contact edge to improve air permeability and comfort
- The plastic splint enhances the support of the cervical spine, maintains the cervical spine in the correct position, and limits its excessive movement
- Suitable for prolonged use of mobile phones or computers with your head down. The posture is incorrect, causing neck tightness, back pain, muscle strain, and shoulder, neck and hand pain.
- 採用硬性多孔聚丙烯機構，於皮膚接觸邊緣採用填充設計，可提高透氣性和舒適性
- 塑膠夾板增強了頸椎的支撐，維持頸椎在正確位置下，限制其過度動作
- 適用於長時間低頭導致肩頸痛、肌肉勞損，引起肩、頸及手的痛症



Specifications

| | |
|-----------------------|--|
| Product model 產品型號 | JAC |
| Product function 產品功能 | cervical traction stretch 頸椎牽引拉伸 |
| Material 材質 | rigid porous polypropylene + edge filling 硬性多孔聚丙烯+邊緣填充 |
| Applicable parts 適用部位 | neck 頸部 |
| Suitable for 適用於 | Neck : 32-37cm (M) 37-42cm (L) 頸圍 : 32-37cm (M) 37-42cm (L) |
| Size 尺寸 | 52.5*6.5cm / 57.5*6.5cm |
| Weight 重量 | 80g/85g |
| Packing size 包裝尺寸 | 25.5*20*7cm |
| Package weight 包裝重量 | 0.20kg/0.21kg |



注意事項:

- ◆ 此產品為頸椎支撐護具，請確保使用前諮詢醫師或相關醫護人員。
- ◆ 未成年人、無自理能力者、淺感覺減退者需在監護人看護下使用。
- ◆ 請正確使用該產品，避免因不當使用造成意外傷害。

Soft Cervical Spine Strengthening Support

軟式頸椎強化支撐護具

Model: JR

Features:

- It contains plastic sheet to provide stable support for the injured and unstable neck
- It can support the neck and maintain the function
- Glued design, easy to wear
- Soft, sweat absorbing, cotton material
- It is used for cervical spondylosis and has good analgesic effect on various cervical injuries
- 內置塑膠片，給受傷不穩定的頸部提供穩定的支撐
- 可支撐頸部保持功能位
- 粘扣式設計，穿戴方便
- 柔軟、吸汗、全棉材質
- 適用於：頸椎病，對各種頸椎損傷，有良好的鎮痛效果



Specifications

| | |
|---------------------------|--|
| Product model 產品型號 | JR |
| Product function 產品功能 | cervical spine support 頸椎支撐 |
| Product material 產品材質 | ingredient 100%棉 |
| Product filling 填充物 | 100% PU |
| Washing instructions 洗滌說明 | hand wash, hang to dry 可手洗，懸掛晾乾 |
| Product color 顏色 | light gray 淺灰色 |
| Size 尺寸 | neck circumference:36-48cm collar height:7.5-8.5cm 頸圍:36-48cm(L) 40-54(XL) 圍領高度:7.5-8.5cm(L/XL) |
| Product weight 產品重量 | 102g |
| Packing size 包裝尺寸 | 28.5*13*9cm |
| Package weight 包裝重量 | 0.21kg |

注意事項:

- ◆ 此產品為頸椎支撐護具，請確保使用前諮詢醫師或相關醫護人員。
- ◆ 未成年人、無自理能力者、淺感覺減退者需在監護人看護下使用。
- ◆ 請正確使用該產品，避免因不當使用造成意外傷害。
- ◆ 避免高溫環境，遠離火源及可能的熱源。
- ◆ 避凝血機制嚴重障礙者、心理障礙者、精神疾病者不建議使用。
- ◆ 對於皮膚不耐熱或敏感(壓力)的患者慎用。

Height Adjustable Neck Bracket

高度可調式頸托

Model: JT

Features:

- The inner lining improves the cushioning effect without deformation, which is conducive to long-term use
- CT and mri were not affected. The height and neck circumference can be adjusted
- Press and rotate the yellow button to adjust the height of neck support
- Assisted physical therapy and rehabilitation
- Indications: back pain, neck and shoulder pain, dizziness and headache, neck stiffness, muscle swelling, neck and shoulder disc protrusion, back column bending
- 內襯提升緩衝效能, 不變形, 有利於長期使用
- 不影響CT、磁共振檢查, 高度及頸圍均可調節
- 按壓並旋轉黃色按鈕可調節頸托高度
- 輔助物理治療及康復
- 適應症: 腰酸背痛、頸肩酸痛、頭暈頭痛、脖子僵硬、肌肉酸脹、頸肩盤突出、背柱彎曲



Specifications

| | |
|-----------------------|---|
| Product Model 產品型號 | JT |
| Product Function 產品功能 | cervical traction stretch 頸椎牽引拉伸 |
| Product Material 產品材質 | ingredient 100%棉 |
| Specification 規格 | model 大號 |
| Size 尺寸 | neck circumference: 46-60cm collar height: 15cm 適用頸圍: 46-60cm 圍領高度: 15cm |
| Product Weight 產品重量 | 200g |
| Packing Size 包裝尺寸 | 25*27*25cm |
| Package Weight 包裝重量 | 0.30kg |



注意事項:

- ◆ 適用於一般的頸椎疾病, 特殊情況或診斷不明確的(例如腫瘤、頸部血管問題等), 應在醫生指導下進行頸部牽引。
- ◆ 此產品為頸椎支撐護具, 請確保使用前諮詢醫師或相關醫護人員。
- ◆ 未成年人、無自理能力者、淺感覺減退者需在監護人看護下使用。

Adjustable Cervical Fixation Brace (M)

可調節頸椎固定支具

Model: JBD

Features:

- The product adopts six adjustable levels, suitable for different groups of people
- The lining is made of softer foam cotton, which does not hurt the skin, clings to the cervical vertebra, and has good fixation effect
- Adjustable lifting, ergonomic design
- For cervical fixation, cervical degenerative spondylitis, cervical fracture or postoperative support
- 該產品採用六檔高低可調，適合不同人群
- 內襯採用較軟泡沫棉，不傷皮膚，緊貼頸椎、固定效果好
- 可調節升降，人體工學設計
- 適用於：頸椎固定、頸部退化性頸椎炎、頸部骨折或術後支撐



Specifications

| | |
|-----------------------|---|
| Product model 產品型號 | JBD |
| Product function 產品功能 | cervical traction and stretching 頸椎牽引拉伸 |
| Product material 產品材質 | ABS+ foam cotton ABS+泡沫棉 |
| Specification 規格 | adult M size, height 160-180cm 成人 M號 適合身高160-180cm |
| Power 模式 | 6 levels adjustable 6檔可調 |
| Product weight 產品重量 | 190g |
| Packing size 包裝尺寸 | 26.5*19*16cm |
| Package weight 包裝重量 | 0.32kg |



注意事項:

- ◆ 此產品為頸部固定支撐護具，請確保使用前諮詢醫師或相關醫護人員。
- ◆ 請正確使用該產品，避免因不當使用造成意外傷害。

Door-suspended Cervical Traction Device

門懸式頸椎牽引器

Model: JDB

Features:

- Relieving discomfort, skin friendly and breathable, small and light, correcting cervical vertebra
 - The steel ring is fixed and adopts the steel ring design, which is solid and durable
 - Breathable fabric, surface canvas, high-density webbing, good breathability
 - Strong velcro, strong adhesion to prevent falling off, tensile and tear resistance
 - Secure buckle, freely adjustable, easy to operate
-
- 舒緩不適, 親膚透氣, 小巧輕盈, 矯正頸椎
 - 鋼圈固定, 採用鋼圈設計, 結實耐用
 - 透氣布料, 表面帆布、高密度織帶, 透氣性好
 - 強力魔术貼, 強粘力防止脫落, 耐拉耐撕
 - 牢固搭扣, 可自由調節, 操作簡單



Specifications

| | |
|-----------------------|--|
| Product model 產品型號 | JDB |
| Product function 產品功能 | cervical traction stretch 頸椎牽引拉伸 |
| Material 材質 | Stainless steel+diving material 不銹鋼+潛水料 |
| Applicable parts 適用部位 | neck 頸部 |
| Size 尺寸 | rope length 1.5m, pad neck width 50cm 繩長1.5m, 墊頸寬50cm |
| Weight 重量 | 444.5g |
| Packing size 包裝尺寸 | 26.5*19*15.5cm |
| Package weight 包裝重量 | 460g |



注意事項:

- ◆ 不要漂白, 不要機洗
- ◆ 請使用合適的頸部牽引以避免受傷
- ◆ 僅使用頸部牽引, 不要雙腳離地懸掛身體
- ◆ 將頸部擔架放在門上, 每天15分鐘

Neck Holder

頸托固定器

Model: JDS

Features:

- Close to skin pores, breathable to avoid sweating, more comfortable to wear
- The curved surface is suitable for human mandible structure, ergonomic design and more comfortable
- 360° adjustable, adjust the angle according to your heart, and adjust the neck bracket angle according to your neck condition
- 親膚小孔, 透氣避免出汗, 穿起來更舒服
- 曲面適合人體下頷骨結構, 符合人體工程學設計, 無縫貼合, 不硌骨, 更舒適
- 360°可調, 隨心調節角度, 可根據自身的脖頸情況調整頸托角度

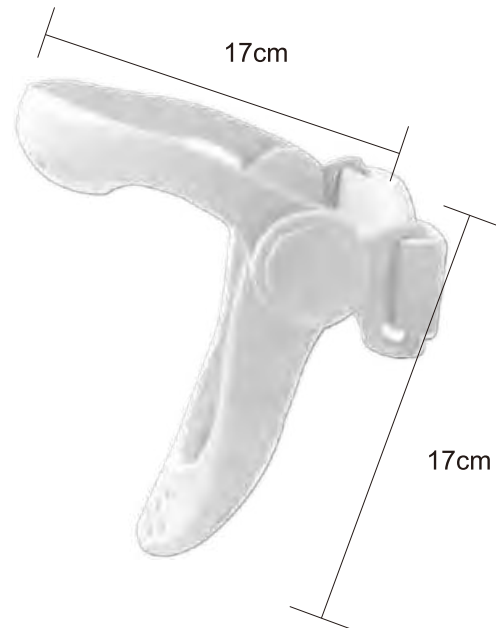

Specifications

| | |
|-----------------------|--|
| Product model 產品型號 | JDS |
| Product function 產品功能 | cervical traction and stretching 頸椎牽引拉伸 |
| Product material 產品材質 | PP |
| Color 顏色 | white 白色 |
| Power 模式 | 17*17*4cm |
| Product weight 產品重量 | 160g |
| Packing size 包裝尺寸 | 25*17*5cm |
| Package weight 包裝重量 | 0.23kg |

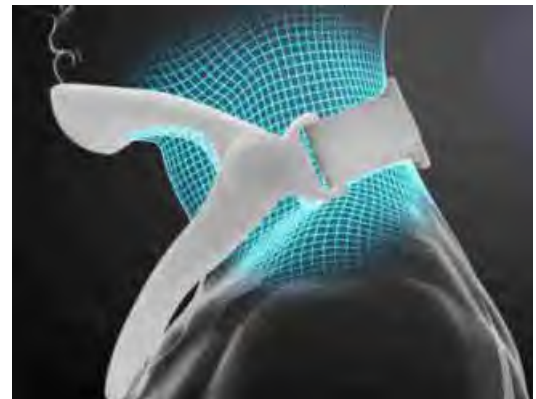

注意事項:

- ◆ 此產品為頸部固定支撐護具, 請確保使用前諮詢醫師或相關醫護人員。
- ◆ 請正確使用該產品, 避免因不當使用造成意外傷害。

Cervical Traction Fixator

頸椎牽引固定器

Model: JED

Features:

- 360 ° wrap support for neck rest
- One-piece design, adjustable tightness, easy to wear, removable neck protection
- Widen the edge and sponge wrap the edge to improve the overall comfort
- Adjust the tightness and position by yourself

- 360°包裹支撐, 讓頸部得到充分休息
- 一體式設計, 鬆緊可調節, 佩戴方便, 可拆式護頸
- 加寬邊緣, 海綿包裹邊緣, 提升整體舒適性能
- 鬆緊調節, 自行調整鬆緊及位置



Specifications

| | |
|-----------------------|-------------------------------------|
| Product model 產品型號 | JED |
| Product function 產品功能 | cervical traction stretch 頸椎牽引拉伸 |
| Material 材質 | sponge 海綿 |
| Applicable parts 適用部位 | neck 頸部 |
| Size 尺寸 | 50*9*3cm |
| Weight 重量 | 55g |
| Packing size 包裝尺寸 | 20*10*10cm |
| Package weight 包裝重量 | 0.12kg |



注意事項:

- ◆ 請勿長期置於高溫場所, 以免變形

Cervical spine fixation brace for children

兒童頸椎固定支具

Model: JBE

Features:

- Four levels of height adjustment, Velcro circumference adjustment
- No metal design, no need to disassemble during X-ray, CT and other inspections
- The front opening adopts a large V-shaped design for easy monitoring, inspection and ventilation
- Indications: back pain, neck and shoulder pain, dizziness and headache, neck stiffness, muscle swelling, neck and shoulder disc protrusion, back column bending
- 四檔高低調節, 魔术貼圍度調節
- 無金屬設計, 在進行X光、CT等檢查時無需拆卸, 避免造成二次傷害
- 前部開口採用大V型設計, 便於監測、檢查和透氣
- 適應症: 腰酸背痛、頸肩酸痛、頭暈頭痛、脖子僵硬、肌肉酸脹、頸肩盤突出、脊柱彎曲



Specifications

| | |
|-----------------------|--|
| Product model 產品型號 | JBE |
| Product function 產品功能 | cervical traction and stretching 頸椎牽引拉伸 |
| Product material 產品材質 | ABS+ foam cotton ABS+泡沫棉 |
| Specification 規格 | children can be adjusted 兒童均碼可調節 |
| Power 模式 | 4 levels adjustable 4檔可調 |
| Product weight 產品重量 | 90g |
| Packing size 包裝尺寸 | 26.5*19*16cm |
| Package weight 包裝重量 | 0.19kg |



注意事項:

- ◆ 此產品為頸部固定支撐護具, 請確保使用前諮詢醫師或相關醫護人員。
- ◆ 請正確使用該產品, 避免因不當使用造成意外傷害。



Thoracic & Lumbar Traction Device

胸&腰椎牽引

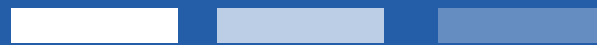

Inflatable Lumbar Traction Device With Magnet

帶磁石充氣腰椎牽引器

Model: JCH

Features:

- Adopt upright traction for sustainable traction support for dozens of hours;
- 25 air expansion columns, strong traction, dual effect of waist treatment and waist protection
- Equipped with 2 magnets, you can also do magnetic therapy while doing traction;
- Applicable : people with lumbar disc herniation, lumbar muscle strain, sciatica, back abdominal pain, and patients with cold pain in the waist and abdomen.
- 採用直立式牽引,可持續牽引支撐數十小時
- 25條空氣膨脹柱,牽引力度大,治腰護腰雙重功效
- 配有2顆磁石,做牽引的同時還可以做磁療
- 適用人群: 腰椎間盤突出、腰肌勞損、坐骨神經痛、背部腹痛人群, 腰部、腹部寒冷疼痛患者

Specifications

| | |
|----------------------------------|---|
| Product model 產品型號 | JCH |
| Product function 產品功能 | lumbar traction, magnetic therapy 腰部牽引, 磁療 |
| Product material 產品材質 | PU+cotton PU+棉 |
| Pressure 承受壓力 | 0.17mpa (max) |
| Size 尺寸 | 115*13cm |
| Inflatable expansion size 充氣展開尺寸 | 115*20cm |
| Lengthened belt 加長帶 | 25*11cm |
| Accessories 配件 | hand pump + extension pad 手打氣筒+延長墊 |
| Weight 重量 | 354g |
| Packing size 包裝尺寸 | 26.8*20.3*8.5cm |
| Package weight 包裝重量 | 8.5kg |

注意事項:

- ◆ 建議使用前解下皮帶或腰部飾物,睡前使用30分鐘,睡眠時應解下氣壓牽引帶。
- ◆ 高血壓、心臟病、腦血管疾病在專業醫護人員的指導下進行。
- ◆ 充氣是漸進式的,不要太多,否則容易產生不適,如果出現腰痛等異常疼痛,請慢慢放氣直到不適狀態消失,然後重新調整。
- ◆ 安全氣囊在使用過程中應避免與硬物接觸;未使用時用濕水毛巾將污漬清除乾淨,不得沖洗,不得用力摩擦。



Inflatable Hot Compress Lumbar Traction Device

充氣熱敷型腰椎牽引器 Model: JCI

Features:

- Anti-C radian traction, protect the waist
 - Atmospheric column traction, the diameter of the air column is 21cm, and the support of the tractor is stable and powerful
 - Deep airway ventilation is not stuffy
 - Applicable population: people with lumbar disc herniation, lumbar muscle strain, sciatica, back and abdominal pain, and patients with cold pain in the waist and abdomen
-
- 反C弧度牽引, 懂腰呵護腰, 腰部問題不在困擾
 - 大氣柱牽引, 氣柱直徑21cm, 相當於氣壓0.5KP, 讓牽引器的支撐穩定有力
 - 深氣道通氣不悶熱, 透氣孔設計, 佩戴後空氣流動通暢
 - 適用人群: 腰椎間盤突出、腰肌勞損、坐骨神經痛、背部腹痛人群, 腰部、腹部寒冷疼痛患者



Specifications

| | |
|----------------------------|--|
| Product model 產品型號 | JCI |
| Product function 產品功能 | lumbar traction, magnetic therapy, hot moxibustion physiotherapy 腰部牽引, 磁療, 熱灸理療 |
| Product material 產品材質 | PU+cotton PU+棉 |
| Rated voltage 額定電壓 | 5V |
| Power supply 供電方式 | USB, power supply USB 電源 |
| Measureing time 加熱溫度 | 45°C~60°C |
| Lengthened belt size 加長帶尺寸 | 13cm |
| Accessories 配件 | Hand pump 手打氣筒 |
| Weight 重量 | 537g |
| Packing size 包裝尺寸 | 21*25.5*7cm |
| Package weight 包裝重量 | 0.65kg |



注意事項:

- ◆ 建議使用前解下皮帶或腰部飾物, 睡前使用30分鐘, 睡眠時應解下氣壓牽引帶。
- ◆ 高血壓、心臟病、腦血管疾病在專業醫護人員的指導下進行。
- ◆ 充氣是漸進式的, 不要太多, 否則容易產生不適, 如果出現腰痛等異常疼痛, 請慢慢放氣直到不適狀態消失, 然後重新調整。
- ◆ 安全氣囊在使用過程中應避免與硬物接觸; 未使用時用濕水毛巾將污漬清除乾淨, 不得沖洗, 不得用力摩擦。

Widened inflatable hot compress Lumbar tractor

加寬充氣熱敷腰椎牽引器

Model: JCJ

Features:

- Vertical traction is adopted. After inflation, the waist can achieve the function of traction support
- Double Velcro can be adjusted and fixed to achieve the best traction state
- Applicable population: it is used for the prevention and adjuvant treatment of lumbar diseases such as lumbar disc herniation and lumbar facet joint dysfunction. It is more suitable for people with higher body
- 採用直立式牽引, 充氣之後, 使腰部達到牽引支撐的作用
- 雙魔术貼可以進行調整固定, 達到牽引最佳狀態
- 適用人群: 用於腰椎間盤突出症, 腰椎小關節功能紊亂等腰椎病的預防和輔助治療, 更適合身體較高的人群使用



Specifications

| | |
|-------------------------------------|---|
| Product model 產品型號 | JCJ |
| Product function 產品功能 | lumbar traction, hot compress, magnetic therapy 腰部牽引, 熱敷, 磁療 |
| Product material 產品材質 | PU, TPU, cotton fabric PU, TPU, 綿織布 |
| Mode of fever 發熱方式 | electric heating 電加熱 |
| Inflation times 充氣次數 | 15-20 reps 手打15-20次充滿 |
| Size 尺寸 | 110*16cm |
| Inflatable expansion size 充氣展開尺寸 | 113*22cm |
| Lengthened belt 加長帶 | 25.5*19.5cm |
| Accessories 配件 | hand pump + extension pad 手打氣筒+延長墊 |
| Weight 重量 | 480g |
| Packing size 包裝尺寸 | 27*20*10cm |
| Package weight 包裝重量 | 0.98kg |

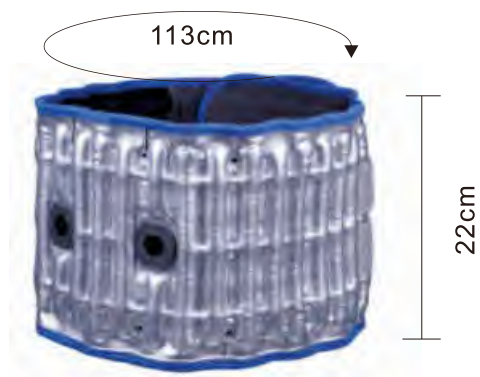

注意事項:

- ◆ 高血壓、心臟病、腦血管疾病在專業醫護人員的指導下進行。
- ◆ 充氣是漸進式的, 不要太多, 否則容易產生不適, 如果出現腰痛等異常疼痛, 請慢慢放氣直到不適狀態消失, 然後重新調整。
- ◆ 安全氣囊在使用過程中應避免與硬物接觸; 未使用時用濕水毛巾將污漬清除乾淨, 不得沖洗, 不得用力摩擦。

Men's Lumbar Fixed Protection Belt

男士腰椎固定護腰

Model: KF

Features:

- Ergonomic design, fits the waist
- Built-in magnet: double pressurized support magnet dot matrix waist protector
- Three-dimensional knitting technology, soft and hard, more elastic
- Apply pressure to muscles, adjust the balance of exercise and balance the force, strengthen muscle strength
- Suitable for: running, regaining, lumbar recovery, driving, etc.
- 人體工學設計, 貼合腰圍
- 內置磁石: 雙重加壓穩固支撐磁石點陣護腰
- 三維針織科技, 軟硬有度, 彈性更強
- 對肌肉施加壓力, 調節運動受力平衡加強肌肉力量
- 適用於: 跑步、收腹、腰椎恢復、開車等



Specifications

| | |
|-----------------------|---|
| Product Model 產品型號 | KF |
| Product Function 產品功能 | lumbar fixed support 腰部固定支撐 |
| Product Material 產品材質 | three-dimensional knitted fabric 三維針織面料 |
| Specification 規格 | M (2-7-3 waist) adult M (適合腰圍2尺7-3尺) 成人 |
| Suitable for 適用於 | hip circumference: 80-90cm 適用髖圍: 80-90cm |
| Color 顏色 | blue + light gray 藍+淺灰色 |
| Product Weight 產品重量 | 480 g |
| Packing Size 包裝尺寸 | 25.5*20*7cm |
| Package Weight 包裝重量 | 0.56kg |



注意事項:

- ◆ 佩帶於胯骨上方與軟肋弓下方, 固定好魔術貼。
- ◆ 高血壓、心臟病、腦血管疾病在專業醫護人員的指導下進行。
- ◆ 儘量放鬆腰部佩戴, 正確使用該產品, 避免因不當使用造成意外傷害。

Special abdominal strap for pregnant women

孕婦專用托腹帶

Model: JJ

Features:

- Lift up the abdomen, so that pregnant women can reduce abdominal pressure and relieve waist and abdomen fatigue
- Select high-quality gauze, which is healthier, softer and has good sag and wear resistance
- Upgrade gauze to be healthy and breathable, and bid farewell to the winding and muggy of traditional binding belt
- Applicable to: pregnant women, abdominal surgeons and other abdominal support
- 托起腹部,讓孕婦減輕腹部壓力,緩解腰腹部疲勞
- 甄選優質紗布,更加健康、更親膚柔軟具有垂性、耐磨性好
- 升級紗布健康透氣,告別傳統束縛帶纏繞與悶熱
- 適用於:孕婦、腹部手術者等腹部支撐



Specifications

| | |
|--|------------------------------|
| Product model 產品型號 | JJ |
| Product material 產品材質 | full stretch fabric 全彈力布料 |
| Model 型號 | adult M code 成人M碼 |
| Color 顏色 | white 白色 |
| Practical abdominal Circumference 實用腹圍 | about 90cm 約90cm左右 |
| Packing size 包裝尺寸 | 25.5*20*7cm |
| Package weight 包裝重量 | 0.31kg |



注意事項:

- ◆ 請謹遵醫囑使用。
- ◆ 使用出現過敏時禁用。
- ◆ 禁忌症皮膚不明腫塊出現者禁用。
- ◆ 皮膚腫破潰瘍者禁用。

Compression sports waist protector

加壓運動護腰固定器

Model: JK

Features:

- Artificial curve design, strengthened fixation, double protection
 - High-adhesive Velcro, easy to fix, adjustable elasticity, easy to wear
 - Breathable fabric, natural skin-friendly, soft and comfortable.
 - Not easy to deform, durable, fine stitches, quality guaranteed
 - Suitable for: for men and women, nursing and recovery after lumbar spine surgery, lumbar muscle strain, back correction, etc.
- 人工學曲線設計, 加強固定, 雙重保護
 - 高粘魔术貼, 輕鬆固定, 鬆緊可調, 穿戴方便
 - 透氣面料, 自然親膚柔軟舒適
 - 不易變形, 持久耐用, 縫線精細, 品質有保證
 - 適用於: 男女通用, 腰椎術後護理恢復、腰肌勞損、背部矯正等使用



Specifications

| | |
|-----------------------|---|
| Product Model 產品型號 | JK |
| Product Function 產品功能 | lumbar fixation 腰椎固定 |
| Product Material 產品材質 | polyester fiber 聚酯纖維 |
| Color 顏色 | black 黑色 |
| Specifications 規格 | M / L / XL |
| Specification 規格 | total waist length: 95cm/98cm/105cm 腰圍總長度: 95cm/98cm/105cm |
| Product Weight 產品重量 | 356g / 381g / 410g |
| Packing Size 包裝尺寸 | 25.5*20*7cm |
| Package Weight 包裝重量 | 0.43kg / 0.50kg / 0.53kg |



注意事項:

- ◆ 取出產品, 根據自己的需求調節大小, 粘上魔术貼即可。
- ◆ 請正確使用該產品, 避免因不當使用造成意外傷害。

Spinal Thoracic Postoperative Fixator

脊椎胸椎術後固定器

Model: JI

Features:

- Artificial curve design, strengthened fixation, double protection
- High-adhesive Velcro, easy to fix, adjustable elasticity, easy to wear
- Breathable fabric, natural skin-friendly, soft and comfortable
- Not easy to deform, durable, fine stitches, quality guaranteed
- Suitable for: postoperative nursing recovery of vertebrae and thoracic spine, compression and fixation of ribs, etc
- 人工學曲線設計, 加強固定, 雙重保護
- 高粘魔術貼, 輕鬆固定, 鬆緊可調, 穿戴方便
- 透氣面料, 自然親膚柔軟舒適
- 不易變形, 持久耐用, 縫線精細, 品質有保證
- 適用於: 脊椎胸椎術後護理恢復、肋骨壓縮固定等



Specifications

| | |
|-------------------------|---|
| Product Model 產品型號 | J1 |
| Product Material 產品材質 | low temperature plastic plate 低溫可塑形板 |
| Model 型號 | one size 均碼 |
| Color 顏色 | gray 灰色 |
| Applicable parts 適用部位 | waist 腰部 |
| Suitable waistline 適合腰圍 | 72-113cm |
| Packing size 包裝尺寸 | 53*23*29cm |
| Package weight 包裝重量 | 1.13kg |



注意事項:

- ◆ 取出產品, 根據自己的需求調節大小, 粘上魔術貼即可。
- ◆ 高血壓、心臟病、腦血管疾病在專業醫護人員的指導下進行。
- ◆ 儘量放鬆腰部佩戴, 正確使用該產品, 避免因不當使用造成意外傷害。

Chest Rehabilitation Fixed Protector

胸部康復固定護具

Model: JBW

Features:

- Triple compression, elastic, comfortable and breathable
- Lightweight fabric, double-layer ventilation, elastic tension strap for comfort
- High viscosity Velcro, easy adjustment, fixed bandage, not easy to fall off
- Meticulous edging, meticulous stitching, soft and comfortable, without cutting hands
- Suitable for: lumbar muscle strain, back correction, etc
- 三重加壓彈性舒適透氣
- 輕盈面料雙層透氣, 彈性拉力綁帶, 穿戴舒適
- 高粘魔術貼, 輕鬆調節, 固定綁帶, 不易脫落
- 細緻包邊, 縫線縝密, 柔軟舒適, 不割手
- 適用於: 腰肌勞損、背部矯正等使用



Specifications

| | |
|----------------------------|--|
| Product Model 產品型號 | JBW |
| Material 材質 | breathable mesh + ok cloth 透氣網布+OK布 |
| Product Specification 產品規格 | L號 |
| Colour 模式 | velcro adjustable size 魔術貼可調節大小 |
| Suitable For 適用於 | waist circumference 80-110cm 腰圍80-110cm 2尺6-3尺3 |
| Product Size 產品尺寸 | 107*17.5*2cm |
| Product Weight 產品重量 | 215g |
| Package Size 包裝尺寸 | 25.5*20*7cm |
| Package Weight 包裝重量 | 0.44kg |

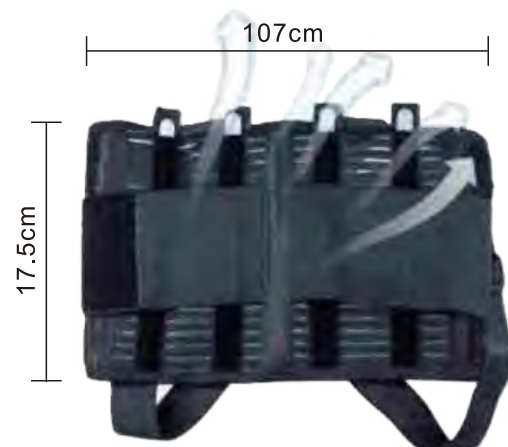

注意事項:

- ◆ 取出產品, 根據自己的需求調節大小, 粘上魔術貼即可。
- ◆ 請確保使用前諮詢醫師或相關醫護人員。
- ◆ 儘量放鬆腰部佩戴, 正確使用該產品, 避免因不當使用造成意外傷害。

Spinal Thoracic Postoperative Fixator

脊椎胸椎術後固定器

Model: JCX

Features:

- Simulate human spine support, comfortable to wear, and accurately fit the waist and spine
- Double-circle compression mode, three-dimensional traction design, abdominal retraction and chest lifting, stretching spine, and dispersing lumbar pressure
- Three kinds of replaceable gaskets are available in four seasons.
- It uses latex silk, with good elasticity, strong retraction, good breathability, and is not stuffy to wear
- Applicable to: sedentary, waist pain, waist relief and other people
- 仿生脊椎骨，強力支撐，模擬人體脊椎骨支撐，佩戴舒適，準確貼合腰部脊椎
- 雙重環繞加壓模式，立體牽引設計，收腹提胸，拉伸脊椎，分散腰椎壓力
- 替換墊片四季可用三種可替換墊片。
- 採用乳膠絲，彈性好回縮性強，透氣性好，佩戴不悶熱
- 鉤面細密平滑，手感柔軟不劃手，強粘附力，使用壽命長
- 適用於：久坐、腰部酸痛、腰部舒緩等人群



Specifications

| | |
|-------------------------|----------------|
| Product Model 產品型號 | JCX |
| Product Material 產品材質 | latex silk 乳膠絲 |
| Model 型號 | XL |
| Color 顏色 | gray 灰色 |
| Applicable parts 適用部位 | waist 腰部 |
| Suitable waistline 適合腰圍 | 94-114cm |
| Packing size 包裝尺寸 | 25.5*20*7cm |
| Package weight 包裝重量 | 583g |

注意事項:

- ◆ 取出產品，根據自己的需求調節大小，粘上魔術貼即可。
- ◆ 高血壓、心臟病、腦血管疾病在專業醫護人員的指導下進行。
- ◆ 儘量放鬆腰部佩戴，正確使用該產品，避免因不當使用造成意外傷害。

Magnetic Therapy Self-heating Waist Protection

磁療自發熱護腰

Model: JCY

Features:

- Marlin's self-heating, intermittent heating, constant temperature hot compress for waist protection
- Magnet acupoint maintenance can relieve waist pain
- 瑪琳自發熱點點陣發熱, 恒溫熱敷護腰
- 磁石穴位養護, 緩解腰部酸痛



Specifications

| | |
|---------------------|---------------------|
| Product Model 產品型號 | JCY |
| Material 材質 | velcro+PU 魔术貼+PU |
| Magnets磁石數量 | 12 |
| Colour 顏色 | black 黑色 |
| Product Size 產品尺寸 | 110*14*1cm |
| Product Weight 產品重量 | 113g |
| Package Size 包裝尺寸 | 15.5*15*5cm |
| Package Weight 包裝重量 | 164g |



注意事項:

- ◆ 如果你發現不適, 請立即停止使用
- ◆ 避免高溫環境, 遠離一切熱源
- ◆ 避免長時間在潮濕環境下使用, 保持產品處於乾燥狀態

Waist Protection With Waist Support

帶腰托護腰

Model: JDY

Features:

- Securer fixation, not easy to detach
- Fabric is breathable and soft
- Avoid sports injury, relieve fatigue, and help the postoperative recovery of lumbar spine
-
-
- 固定更牢固, 不易脫離
- 面料透氣、柔軟
- 避免運動傷害、緩解疲勞、幫助腰椎部術後恢復
-
-



Specifications

| | |
|-----------------------|----------------------------------|
| Product Model 產品型號 | JDY |
| Product Material 產品材質 | Stretch fabric+buckle 彈力面料+卡扣 |
| Product size 產品尺寸 | 95*26cm |
| Product weight 產品重量 | 400g |
| Packing size 包裝尺寸 | 32*25*9cm |
| Package weight 包裝重量 | 0.6kg |



注意事項:

- ◆ 如果你發現不適, 請立即停止使用
- ◆ 避免高溫環境, 遠離一切熱源
- ◆ 避免長時間在潮濕環境下使用, 保持產品處於乾燥狀態

Wormwood self-heating belt

艾草自發熱護腰帶

Model: JFO

Features:

- 360 ° comprehensive waist protection, maintenance and protection give comprehensive care to the waist
- Airong physiotherapy, carefully care for your waist and abdomen health
- Sweat-wicking and breathable, high-quality fabric, breathable and comfortable
- 360°全面護腰, 養護防護給腰部全面呵護
- 艾絨理療, 細心呵護您的腰腹健康
- 排汗透氣, 優質面料, 親膚透氣舒爽



Specifications

| | |
|----------------------------|-------------------------|
| Product Model 產品型號 | JFO |
| Material 材質 | Polyester fiber 聚酯纖維 |
| Product Specification 產品規格 | M號 |
| Suitable For 適用於 | (55-70KG) (110-140斤) |
| Product Size 產品尺寸 | 90*19cm |
| Product Weight 產品重量 | 142g |
| Package Size 包裝尺寸 | 15*15*5cm |
| Package Weight 包裝重量 | 0.2kg |



注意事項:

- ◆ 取出產品, 根據自己的需求調節大小, 粘上魔術貼即可。
- ◆ 請確保使用前諮詢醫師或相關醫護人員。
- ◆ 儘量放鬆腰部佩戴, 正確使用該產品, 避免因不當使用造成意外傷害。

Hip Joint Pelvic Fixed Brace

髖關節骨盆固定支具

Model: JEH

Features:

- Adjustable design, adjustable binding to control tightness
- Perforated lining for comfort and breathability

- 可調節設計, 調節綁帶控制鬆緊
- 採用打孔內襯設計, 舒適透氣



Specifications

| | |
|-----------------------|------------|
| Product Model 產品型號 | JEH |
| Product Material 產品材質 | PP |
| Color 顏色 | gray 灰色 |
| Applicable parts 適用部位 | hip 髖部 |
| Product size 產品尺寸 | 30*25*20cm |
| Product weight 產品重量 | 600g |
| Packing size 包裝尺寸 | 40*40*25cm |
| Package weight 包裝重量 | 0.8kg |



注意事項:

- ◆ 取出產品, 根據自己的需求調節大小, 粘上魔術貼即可。
- ◆ 高血壓、心臟病、腦血管疾病在專業醫護人員的指導下進行。
- ◆ 儘量放鬆腰部佩戴, 正確使用該產品, 避免因不當使用造成意外傷害。



Arm & Shoulder Traction Device

手臂&肩部支撐牽引

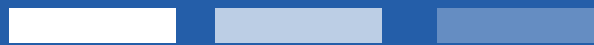

Cold And Warm Shoulder Protection (wormwood/four Seasons)

防寒保暖護肩(艾草自發熱款/四季款)

Model: JFN/JFN2

Features:

- The wormwood is covered by the self-heating dot-matrix of Tomeline, which can keep warm at constant temperature for a long time
- Acupoint maintenance can effectively relieve shoulder pain and discomfort
- It can effectively relieve discomfort around the shoulder by keeping warm and curing with far-infrared light wave
- It is made of high-quality bamboo charcoal fiber, which is hygroscopic and breathable, and suitable for wearing in all seasons
- 艾草款有托瑪琳自發熱點陣覆蓋, 恒溫發熱, 時間長保暖效果佳
- 穴位養護, 有效緩解肩關節酸痛不適等問題
- 通過遠紅外光波保暖養護, 可以有效緩解肩周不適
- 採用優質竹炭纖維, 吸濕透氣, 適宜四季佩戴



JFN-艾草自發熱款



JFN2-四季款

Specifications

| | |
|-----------------------|----------------------|
| Product model 產品型號 | JFN/JFN2 |
| Product material 產品材質 | polyester fiber 聚酯纖維 |
| Specification 規格 | M |
| Color 顏色 | gray 灰色 |
| Shoulder width 適用於肩寬 | 43-46cm |
| Product size 產品尺寸 | 55*16*1cm |
| Product weight 產品重量 | 129g/118g |
| Packing size 包裝尺寸 | 15.5*5*15cm |
| Package weight 包裝重量 | 0.18kg/0.17kg |



注意事項:

- ◆ 取出產品, 將產品穿戴於肩上即可。
- ◆ 貼身佩戴, 佩戴前用溫濕毛巾擦拭效果更佳。
- ◆ 正確使用該產品, 避免因不當使用造成意外傷害。

Forearm Sling

前臂吊帶

Model: JAE

Features:

- Ergonomic design, comfortable to wear, restrict arm movement, left and right, both for men and women
- It is made of highly durable material to provide comfort for patients when the arm and shoulder are fixed
- The thumb ring prevents movement, rotation and provides fixed protection
- Washable and reusable
- 人體工程學設計, 穿戴舒適, 限制手臂前後移動左右兼用、男女兼用
- 高度耐用材料製成, 使手臂和肩膀固定時為患者提供舒適感
- 拇指環則防止移動, 防止旋轉並提供固定保護
- 可拆洗, 反復使用



Specifications

| | |
|-------------------------|---|
| Product model 產品型號 | JAE |
| Material 材質 | 50% polyester fiber, 40% polyurethane, 10% polyamide 50% 聚酯纖維、40% 聚氨酯、10% 聚醯胺% |
| Washing conditions 洗滌條件 | hand wash, hang to dry 可手洗, 懸掛晾乾 |
| Suitable for 適用於 | common to left and right arms 左右手臂通用 |
| Circumference 適合前臂圍 | S 29-34cm M 35-39cm L 40-42cm |
| Size 尺寸 | 40 * 14 * 3cm |
| Weight 重量 | 150g |
| Packing size 包裝尺寸 | 53*23*29cm |
| Package weight 包裝重量 | 1.13kg |

適用於術後固定:

- ◆ 橈骨尺骨骨折後固定
- ◆ 肩關節軟組織損傷後固定
- ◆ 肘關節及前臂軟組織損傷後的前臂懸吊
- ◆ 肩膀脫臼都懸吊, 預防肩關節半脫位

注意事項:

- ◆ 取出產品, 先按照正反方向然後把掛脖帶先帶上, 然後把放手處魔術貼打開把手放入, 根據自己舒適程度調節魔術貼位置。
- ◆ 未成年人、無自理能力者、淺感覺減退者需在監護人看護下使用。
- ◆ 此產品佩戴不易過緊或過松, 佩戴後如病情無好轉, 請及時諮詢醫生。

Shoulder Strap

肩部固定帶

Model: JAF

Features:

- The punched NEOPRENE material is breathable and comfortable, and can be worn comfortably in clothes
- The material is breathable and comfortable, and can be worn comfortably in clothes
- Washable and reusable
- Provides fixation and support for the shoulders and upper arms to help patients gradually recover their exercise ability
- 沖孔的NEOPRENE材料透氣舒適,可舒適地穿戴在衣服裏面
- 材料透氣舒適,可舒適的穿戴在衣服裡面
- 可拆洗,反復使用
- 提供肩部和上臂的固定和支持協助病患部位逐漸恢復運動能力



Specifications

| | |
|---------------------|-------------------------------|
| Product model 產品型號 | JAF |
| Material 材質 | perforated neoprene 沖孔氯丁橡膠 |
| Suitable for 適用於 | for left shoulder 左肩適用 |
| Shoulder width 適合肩寬 | M 34-41cm M 40-46cm M 45-52cm |
| Size 尺寸 | 24.5 * 20 * 2.5 cm |
| Weight 重量 | 0.12kg |
| Packing size 包裝尺寸 | 25.5*20*7cm |
| Package weight 包裝重量 | 0.25kg |

適用症:

- ◆ 防止肩部拉傷,舒緩肩部痛處,固定肩部位置避免過份勞損。
- ◆ 輔助治療肩部扭挫傷、解除疼痛,加速康復,肩部手術後的固定。

注意事項:

- ◆ 取出產品,將產品穿戴於肩上即可。
- ◆ 貼身佩戴,佩戴前用溫濕毛巾擦拭效果更佳。
- ◆ 儘量放鬆佩戴,正確使用該產品,避免因不當使用造成意外傷害。

Shoulder Joint Fixation Band

肩關節固定帶

Model: JAG

Features:

- The specially designed connection between the upper arm and the forearm provides strong supporting force, reduces the pulling on the rotator cuff, and relieves shoulder pain
- The mobility of the forearm is not restricted, and patients can wear this shoulder support for rehabilitation training
- Removable and washable, repeated use
- 上臂和前臂特殊設計的連接，提供強大的承托力，減輕對肩袖的拉扯，緩解肩部疼痛
- 前臂的活動度不受限制，患者可以佩戴此肩托進行康復訓練
- 可拆洗，反復使用



Specifications

| | |
|-------------------------|---|
| Product model 產品型號 | JAG |
| Material 材質 | 70% polyester fiber, 30% polyurethane 70% 聚酯纖維, 30% 聚氨酯 |
| Washing conditions 洗滌條件 | hand wash, hang to dry 可手洗, 懸掛晾乾 |
| Suitable for 適用於 | for left shoulder 左肩適用 |
| Shoulder width 適合肩寬 | S 34-41cm M 40-46cm L 45-52cm |
| Size 尺寸 | 44 * 36 * 3cm |
| Weight 重量 | 220g |
| Packing size 包裝尺寸 | 25.5*20*7cm |
| Package weight 包裝重量 | 0.34kg |

適用症:

- ◆ 預防和輔助治療各種原因導致的肩關節半脫位 (如: 腦卒中後遺症、外周神經損傷等)

注意事項:

- ◆ 將有襯墊置於患肩，綁帶環繞胸廓後，以舒適的鬆緊程度粘結固定即可。
- ◆ 未成年人、無自理能力者、淺感覺減退者需在監護人看護下使用。
- ◆ 不可擅自更改結構設計或預設角度。
- ◆ 此產品佩戴不易過緊或過松，佩戴後如病情無好轉，請及時諮詢醫生。

Multifunctional Arm Strap

多功能手臂固定帶

Model: JD

Features:

- Free adjustment, random length, cross back design, not easy to slip off, more convenient to wear
- Breathable fabric, natural skin-friendly, soft and comfortable
- Velcro, high adhesion, more convenient to use, simple operation, strong adhesion, good fixation
- Apply to: Shoulder clavicle fractures, scapula fractures, arm and upper arm fractures, use together with plaster after surgery, replace triangle scarf after surgery, can be used for stroke patients
- 自由調節, 長短隨意, 背部交叉設計, 不易滑落, 佩戴更方便
- 透氣面料, 自然親膚柔軟舒適
- 魔術貼, 高粘力, 使用更方便, 操作簡單, 粘性強, 固定性好
- 適用於: 肩部鎖骨骨折、骨胛骨折、手臂及上臂骨折、手術後及石膏一起使用、術後代替三角巾, 可用於中風患者



Specifications

| | |
|----------------------------------|---------------------|
| Product model 產品型號 | JD |
| Product material 產品材質 | composite cloth 複合布 |
| Model 型號 | free size 均碼 |
| Color 顏色 | gray 灰色 |
| Folded size 折疊尺寸 | 65cm |
| Suitable for one-arm bust 適合單臂胸圍 | 114-119cm |
| Packing size 包裝尺寸 | 26*19*15.5cm |
| Package weight 包裝重量 | 0.42kg |



注意事項:

- ◆ 取出產品, 先將手臂吊帶根據自己的需求調節至合適位置, 再根據自身需求將胸圍固定帶繞身體一圈粘貼, 此根據自己的需求調節大小和長短。
- ◆ 此產品為手臂保護, 請確保使用前諮詢醫師或相關醫護人員。
- ◆ 請正確使用該產品, 避免因不當使用造成意外傷害。

Forearm Fixation Sling

前臂固定吊帶

Model: JE

Features:

- Breathable and skin-friendly fabric, double load-bearing, non-slip non-shifting, comfortable shoulder pads without hurting the neck, adjustable buckle, free adjustment
- Auxiliary support, strengthen support, maintain a better fixed posture
- The length of the shoulder strap can be adjusted to a comfortable length according to the wearing situation
- Widen and long neck shoulder straps, soft and comfortable, non-corrugated neck
- Applicable to: fixation of fracture dislocation or ligament injury of forearm
- 透氣親膚面料, 雙重承重防滑不移位, 舒適肩墊不傷脖頸, 可調節卡扣, 自由調整
- 輔助承托, 加強支撐, 保持更好的固定姿勢
- 肩帶長度可調節, 根據佩戴情況調到舒適的長度
- 加寬加長護頸肩帶, 柔軟舒適, 不硌頸部
- 適用於: 前臂的骨折脫位或韌帶損傷的固定



Specifications

| | |
|-------------------------------|--|
| Product model 產品型號 | JE |
| Product material 產品材質 | lightweight composite fabric 輕薄複合面料 |
| Model 型號 | free size 均碼 |
| Color 顏色 | black 黑色 |
| Applicable arm size 適用手臂尺寸 | 30cm |
| Weight 重量 | 89g |
| Packing size 包裝尺寸 | 15.5*15*4.5cm |
| Package weight 包裝重量 | 0.15kg |



注意事項:

- ◆ 取出產品, 根據自己的需求調節大小和長短。
- ◆ 此產品為手臂保護, 請確保使用前諮詢醫師或相關醫護人員。
- ◆ 請正確使用該產品, 避免因不當使用造成意外傷害。

Elbow Joint Limit Fixed Tractor

肘關節限位固定牽引器

Model: JV

Features:

- Turntable design, extension and flexion angle can be set every 10°
- Height adjustable, width adjustable
- Silicone gasket to prevent slippage and rotation
- Applicable to:
Fractures in the elbow joint, postoperative fixation and rehabilitation training of the elbow joint
Treatment and rehabilitation training of tendon tear and ligament injury of elbow joint
- 轉盤設計, 每10°可以設定伸展和屈曲角度
- 高度可調, 寬窄可調
- 矽膠墊片, 防止滑脫和轉動
- 適應症:
肘關節內骨折, 術後固定
肘關節肌腱撕裂及韌帶損傷的治療與康復訓練



Specifications

| | |
|------------------------|---|
| Product model 產品型號 | JV |
| Product function 產品功能 | elbow joint fixation 肘關節固定 |
| Product material 產品材質 | 50% polyester fiber, 40% polyurethane, 10% polyamide 50%聚酯纖維, 40%聚氨酯, 10%聚醯胺 |
| Bracket 支架 | 90% aluminum, 10% ABS 90%鋁, 10%ABS |
| Anti-slip coating 防滑塗層 | 100% silicone 100%矽膠 |
| Specification 規格 | adult size 成人碼 |
| Suitable for 適用於 | 29cm and above 適用範圍: 29cm及以上 |
| Product size 產品尺寸 | 53*13*10cm |
| Product weight 產品重量 | 450g |
| Packing size 包裝尺寸 | 35*23*19.5cm |
| Package weight 包裝重量 | 712g |

注意事項:

- ◆ 刻度盤調整方法按下刻度盤兩側轉子的中間按鈕, 可依照患者需求, 調整合適的角度, 放開後即可穩定。按鈕兩側有安全的保護裝置, 防止按鈕受碰撞而改變固定器角度。
- ◆ 將手臂放入產品內, 手掌抓握住手柄, 粘上魔術貼即可
- ◆ 未成年人、無自理能力者、淺感覺減退者需在監護人幫助下使用
- ◆ 諮詢專業人士正確使用產品
- ◆ 凝血機制障礙、血管脆性增高及精神心理有障礙者不建議使用
- ◆ 此產品佩戴應鬆緊適度, 佩戴後如病情無明顯改善, 請及時諮詢醫生或相關專業人員
- ◆ 不可擅自更改結構設計或預設角度, 定期檢查矯形器效能

Intelligent Inductive Corrector

智能感應式矯正器

Model: JDD

Features:

- Intelligent vibration reminder, scientific correction of hump
- Intelligent display screen to record the number of humps
- Rectify and shape, reject hump
- Elastic adjustable shoulder strap, wear without shoulder
- One-button start is convenient and can switch modes

- 智能震動提醒, 科學矯正駝背
- 智能顯示幕, 記錄駝背次數
- 矯正塑形, 拒絕駝背
- 鬆緊可調節肩帶, 佩戴不勒肩
- 一鍵啟動操作便捷, 可切換模式



Specifications

| | |
|-----------------------|--|
| Product model 產品型號 | JDD |
| Product material 產品材質 | ABS+elastic nylon belt ABS+高強度彈性尼龍帶 |
| Rated power 額定功率 | 0.4W |
| Working voltage 工作電壓 | 5V |
| Battery capacity 電池容量 | 400mAh |
| Product size 產品尺寸 | 10*9*1.5cm |
| Weight 重量 | 88g |
| Packing size 包裝尺寸 | 15.5*15*4.5cm |
| Package weight 包裝重量 | 0.15kg |



注意事項:

- ◆ 請勿在睡覺時使用本產品,睡覺時要摘下來,白天的時候戴上。
- ◆ 初次使用本產品請從1-2小時開始,適應後可逐漸延長佩戴時間。
- ◆ 使用產品過程中過分緊系,並長時間佩戴時,呼吸會受到一定影響,請適當調節鬆緊程度即可。

Hunchback Posture Correction Belt

背部肩部駝背姿勢矯正帶

Model: JDR

Features:

- Lightweight and breathable, comfortable to wear inside, straight and straight at all times, front sticky wear, simple and convenient
- Breathable high elastic shoulder strap, comfortable and skin-friendly, durable
- Human body mechanics design, improve hump, support strength and relaxation
- Imitation human spine plastic plate correction, balanced stress, straight to the waist
- 輕薄透氣, 舒適內穿, 時刻挺拔, 前粘式穿戴, 簡單便捷
- 透氣高彈肩帶, 舒適親膚, 久戴不勒
- 人體力學設計, 改善駝背, 支撐力量, 張弛有度
- 仿人體脊椎塑板矯正, 受力均衡, 直達腰部



Specifications

| | |
|-----------------------|---|
| Product model 產品型號 | JDR |
| Product function 產品功能 | back fixation 背部固定 |
| Product material 產品材質 | ABS |
| 顏色 | 灰色+藍色 |
| Specification 規格 | M |
| Suitable for 適用於 | Lower bust range: 81-91cm Height: 155-170cm Weight: 55-70kg 下胸圍範圍: 81-91cm 身高: 155-170cm 體重: 55-70kg |
| Product size 產品尺寸 | support keel: 40cm long, shoulder strap velcro: 80cm long on one side 支撐龍骨: 長40cm, 肩帶魔术貼: 單邊長80cm |
| Product weight 產品重量 | 450g |
| Packing size 包裝尺寸 | 35*23*19.5cm |
| Package weight 包裝重量 | 712g |



注意事項:

- ◆ 禁止暴曬, 陰涼地方曬乾。
- ◆ 不要靠近火源。
- ◆ 使用後請及時清潔。

Shoulder Joint Fixation Protective Belt

肩關節固定保護帶

Model: JEE

Features:

- Made of perforated composite fabric, it is soft to wear, comfortable and elastic to stretch, not sultry and not allergic
 - Safety silicone anti-slip strip, more effective anti-slip
 - The powerful velcro can be adjusted according to its own, and the use effect is better
 - Applicable to: fixation of shoulder joint, prevention of strain and dislocation, prevention of arm sagging and habitual dislocation
- 採用打孔複合面料，佩戴柔軟，舒適彈性伸展，不悶熱不過敏
 - 安全矽膠防滑條，更能有效的防滑
 - 強力魔术貼可調節，可根據自身調節魔术貼，使用效果更好
 - 適用於：肩關節受份固定，防拉傷防脫臼，防止手臂下垂，習慣性脫臼



Specifications

| | |
|-----------------------|---|
| Product model 產品型號 | JEE |
| Product material 產品材質 | ok cloth ok布 |
| Product size 產品尺寸 | shoulder width: 30cm arm circumference: 39cm forearm: 33cm bandage: broadband length is about 100cm, narrow band 90cm 肩圍寬:30cm / 臂圍:39cm / 小臂:33cm 綁帶:寬頻長約100cm, 窄帶90cm |
| Weight 重量 | 200g |
| Packing size 包裝尺寸 | 25*20*7cm |
| Package weight 包裝重量 | 0.31kg |



注意事項:

- ◆ 注意事項:
請勿長期置於高溫場所，以免變形;
請勿接觸明火及腐蝕性液體。

Adjustable Shoulder Abduction Fixed Pillow

可調節肩外展固定枕

Model: JEQ

Features:

- The vent design is not stuffy, and the drawcord design can adjust the tightness at will
- Two bandages, the arm and the waist pillow are integrated to increase the fixation effect, widen and thicken the design, and the arm is not limited
- T-shaped pillow design, adjust according to the comfortable fixed position and posture of the patient's arm, so that the shoulder joint can be fully relaxed and supported
- The grip strength of the ball is relatively light, and proper light grip can exercise the strength of fingers to prevent hand stiffness
- 透氣孔設計不悶熱，拉繩設計可以隨意調節鬆緊
- 兩根綁帶，手臂與腰枕連為一體，增加固定效果，加寬加厚設計，不勒手臂
- T形枕設計，根據患者手臂舒適的固定位置和姿勢調整，使肩關節得到充分的放鬆和支撐
- 握力球力道較輕，適當輕握可鍛煉手指力量，防止手部僵化



Specifications

| | |
|-----------------------|---------------------------|
| Product model 產品型號 | JEQ |
| Product function 產品功能 | shoulder fixation 肩部固定 |
| Product material 產品材質 | composite cloth 複合布 |
| Color 顏色 | black 黑色 |
| Product size 產品尺寸 | 35*35*21cm |
| Product weight 產品重量 | 600g |
| Packing size 包裝尺寸 | 40*40*25cm |
| Package weight 包裝重量 | 0.7kg |



注意事項:

◆ 注意事項:

請勿長期置於高溫場所，以免變形；
請勿接觸明火及腐蝕性液體。

Vest Chest Strap

背心胸部固定帶

Model: JFD

Features:

- Long adjustable shoulder strap, comfortable and soft
- Comfortable skin-friendly fabric, breathable and comfortable, easy to sweat
- Magic adhesive, the front can be pasted, and the tightness can be adjusted at will
- The use of high elastic elastic band makes it convenient for patients to wear and fix freely

- 加長可調肩帶, 舒適柔軟
- 舒適親膚面料, 透氣舒爽, 易於排汗
- 魔術粘貼, 正面可粘貼, 鬆緊隨意調節
- 使用高彈力鬆緊帶, 使患者穿戴方便, 固定自如



Specifications

| | |
|-----------------------|---|
| Product model 產品型號 | JFD |
| Product material 產品材質 | cotton fabric+elastic belt+sponge 棉布料+鬆緊帶+海綿 |
| Color 顏色 | 白色 |
| Specifications 規格 | M |
| For 適用於 | 2.4 feet - 2.8 feet (waist) 2.4尺-2.8尺(腰圍) |
| Product size 產品尺寸 | 36*30cm |
| Weight 重量 | 100g |
| Packing size 包裝尺寸 | 25*17*5cm |
| Package weight 包裝重量 | 0.18kg |



注意事項:

- ◆ 注意事項:
請勿長期置於高溫場所, 以免變形;
請勿接觸明火及腐蝕性液體。

Electric Moxibustion For Shoulder Protection

電熱艾灸護單肩

Model: JFF

Features:

- Honeycomb vent, breathable design is more comfortable to wear, does not affect the body surface temperature, breathable and not stuffy
- It contains a mesh pocket design, a large-capacity mesh pocket, which can be used to place wormwood bags, and moxibustion hot compress to relieve pain
- The seam of the lock is flat, the stitches are fine and tight without dropping, and it is firm and durable
- 蜂窩透氣孔, 透氣設計佩帶更舒適, 不影響鎖住體表溫度, 透氣不悶熱
- 內含網兜設計, 大容量網兜, 可放置艾草包, 艾灸熱敷祛痛
- 鎖邊車縫平整, 針腳細密不掉線, 結實更耐用



Specifications

| | |
|------------------------|---|
| Product model 產品型號 | JFF |
| Product function 產品功能 | shoulder, elbow injury fixation 肩部熱敷 |
| Product material 產品材質 | Ok fabric+carbon fiber Ok布面料+炭纖維 |
| Rated voltage 額定電壓 | 5V |
| Power supply mode 供電方式 | USB |
| Temperature gear 溫度檔位 | high-grade red light 65 °C midrange blue light 55 °C low gear green light 45 °C 高檔紅燈65°C, 中檔藍燈55°C, 低檔綠燈45°C |
| Specification 規格 | 均碼 |
| Product weight 產品重量 | 180g/200g/215g |
| Packing size 包裝尺寸 | 25.5*20*7cm |
| Package weight 包裝重量 | 0.29kg/0.31kg/0.33kg |



注意事項:

- ◆ 禁止睡覺接電使用

Children's Forearm Fracture Sling

兒童前臂骨折吊帶

Model: JBB

Features:

- It is designed with two fixed straps at the shoulder and waist to support the arm and maintain a good fixed posture
- The built-in removable cartilage support plate helps support the arm and maintain the stability of the arm
- Large mesh for comfort and breathability all year round
- Widened shoulder pads help reduce wear pressure
- It is applicable to the fixation of shoulder fracture dislocation or ligament injury. It is easy to use and can replace plaster
- 採用肩部和腰部兩根固定帶設計，承托手臂保持好的固定姿勢
- 內置可拆卸軟骨托板輔助支撐手臂，保持手臂穩定性
- 大網眼舒適透氣四季可用
- 加寬肩墊，有助於減輕佩戴壓力
- 適用於：肩部的骨折脫位或韌帶損傷的固定，使用方便，可代替石膏



Specifications

| | |
|-----------------------|--|
| Product model 產品型號 | JBB |
| Product function 產品功能 | shoulder, elbow injury fixation 肩部, 手肘受傷固定 |
| Product material 產品材質 | breathable mesh 透氣網布 |
| Specification 規格 | S / M / L |
| Suitable for 適用於 | children 3-5 / 6-8 / 9-12 years old 兒童3-5歲 / 6-8歲 / 9-12歲 |
| Color 顏色 | grey 灰色 |
| Product weight 產品重量 | 180g/200g/215g |
| Packing size 包裝尺寸 | 25.5*20*7cm |
| Package weight 包裝重量 | 0.29kg/0.31kg/0.33kg |



注意事項:

- ◆ 根據自己的需求調節大小和長短，再用鎖扣圍繞腰部纏繞一圈固定。
- ◆ 此產品為肩部前臂吊帶，請確保使用前諮詢醫師或相關醫護人員。
- ◆ 請正確使用該產品，避免因不當使用造成意外傷害。

Children's Sprained Shoulder Protector

兒童肩膀扭傷護具 Model: JBC

Features:

- The Velcro design can be easily adjusted and used by yourself
- With armpit inflatable bag design, more effective support for the arm
- It is suitable for the fixation of fracture, dislocation or ligament injury of the shoulder
- 魔術貼設計可以方便自己調節至合適自己的位置,使用更方便
- 附帶腋窩充氣袋設計,更有效的支撐手臂,讓腋窩部位不易出汗
- 適用於:肩部的骨折脫位或韌帶損傷的固定,使用方便



Specifications

| | |
|-----------------------|---|
| Product model 產品型號 | JBC |
| Product function 產品功能 | fingers and wrists are injured and fixed 手指,手腕受傷固定 |
| Product material 產品材質 | composite cloth 複合布 |
| Specification 規格 | children inflatable,can be adjusted 兒童 充氣款 均碼可調節 |
| Suitable for 適用於 | hands 手部 |
| Color 顏色 | blue 藍色 |
| Product weight 產品重量 | 150g |
| Packing size 包裝尺寸 | 25.5*20*7cm |
| Package weight 包裝重量 | 0.28kg |



注意事項:

- ◆ 根據自己需求調節所需大小,魔術貼粘上固定,將充氣袋放入外包口袋充好氣即可。
- ◆ 此產品為肩部前臂吊帶,請確保使用前諮詢醫師或相關醫護人員。
- ◆ 請正確使用該產品,使用時請勿系結過緊,防止壓迫頸部動脈,影響正常呼吸。



Hand Fixing Supporter

手部固定支撐

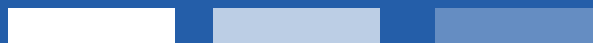

Breathable Wrist Fixing Protective

透氣型手腕固定保護套

Model: JAD

Features:

- Protect fingers and wrists
- Artificial curve design, strengthening fixation and double protection
- Adjustable elasticity, universal left and right, adjustable sliding buckle, easy to wear
- Lightweight fabric, comfortable and breathable
- Suitable for: thumb injury, keyboard hand, prevention and improvement of wrist injury and sports protection
- 可以保護手指和手腕
- 人工學曲線設計, 加強固定, 雙重保護
- 鬆緊可調, 左右通用, 可調節滑扣, 穿戴方便
- 輕薄面料, 舒適透氣
- 適用於: 拇指受傷、鍵盤手, 預防和改善手腕損傷及運動防護



Specifications

| | |
|-----------------------|----------------------------------|
| Product model 產品型號 | JAD |
| Product function 產品功能 | finger injury fixation 手指受傷固定 |
| Material 材質 | composite cloth 複合布 |
| Applicable parts 適用部位 | hands 手部 |
| Specification 規格 | M 中號 |
| Product size 產品尺寸 | 16 * 10 * 3cm |
| Expanded size 展開尺寸 | 30 * 15.5 * 15cm |
| Weight 重量 | 30 g |
| Packing size 包裝尺寸 | 25.5*20*7cm |
| Package weight 包裝重量 | 0.28kg |

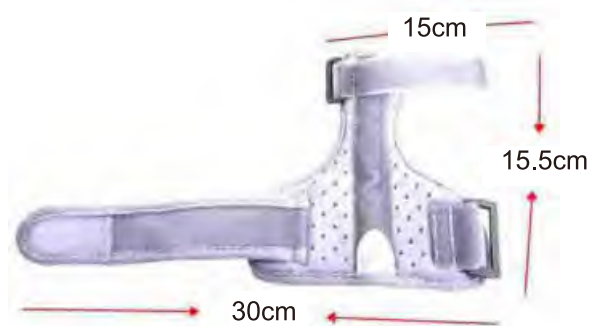

注意事項:

- ◆ 根據自己的需求調節腕部大小和手指大小的是適度來調節即可。
- ◆ 此產品為手腕保護指套, 請確保使用前諮詢醫師或相關醫護人員。
- ◆ 未成年人、無自理能力者、淺感覺減退者需在監護人看護下使用。
- ◆ 請正確使用該產品, 避免因不當使用造成意外傷害。

Thumb Wrist Fixed Protective Sleeve

拇指腕部固定保護套

Model: JAO

Features:

- Artificial curve design, strengthen fixation, light and thin fabric, comfortable and breathable
 - Universal around, high sticky Velcro, easy to fix, adjustable, easy to wear
 - Strengthen the double fixation belt, so that the injured hand secondary protection, promote hand rehabilitation
 - Suitable for: tenosynovitis, thumb injury, keyboard player
-
- 人工學曲線設計, 加強固定, 輕薄面料, 舒適透氣
 - 左右通用, 高粘魔術貼, 輕鬆固定, 鬆緊可調, 穿戴方便
 - 加固雙重固定帶, 讓受傷的手二次保護, 促進手部康復
 - 適用於: 腱鞘炎、拇指受傷、鍵盤手



Specifications

| | |
|------------------------------------|--|
| Product model 產品型號 | JAO |
| Product function 產品功能 | finger injury fixation 手指受傷固定 |
| Product material 產品材質 | composite cloth, aluminum alloy metal strip 複合布 鋁合金金屬條 |
| Model 型號 | free size 均碼 |
| Color 顏色 | royal blue 寶藍色 |
| Part of use 使用部位 | fingers 手指 |
| Finger adjustment length 手指調節長度 | 12.5cm |
| Adjustable wrist length 手腕調節長度 | 31cm |
| Packing size 包裝尺寸 | 23.5*10*7cm |
| Package weight 包裝重量 | 84 g |



注意事項:

- ◆ 根據自己的需求調節腕部大小和手指大小的是適度來調節即可。
- ◆ 此產品為手腕保護指套, 請確保使用前諮詢醫師或相關醫護人員。
- ◆ 未成年人、無自理能力者、淺感覺減退者需在監護人看護下使用。
- ◆ 請正確使用該產品, 避免因不當使用造成意外傷害。

Finger Orthopedic Splint

手指矯形固定夾板

Model: JAI

Features:

- Breathable and comfortable pure cotton lining is made of breathable fabric, which is more durable and lint-free after repeated use
- High adhesive Velcro, easy to fix, adjustable tightness
- A strong base, fits the curve of a healthy finger, has good toughness, and the curve is adjustable
- Light weight, no pressing, small and beautiful, does not affect other finger activities
- Suitable for: finger correction, injured finger fixation, etc.
- 透氣舒適純棉裡布，選用透氣面料，反復使用不起毛透氣更耐用
- 高粘魔術貼，輕鬆固定，鬆緊可調
- 結實底托，貼合健康手指弧線，韌性好，弧度可調
- 重量輕，不壓手，小巧美觀不影響其他手指活動
- 適用於：手指矯正、受傷手指固定等需求



Specifications

| | |
|-----------------------|---|
| Product model 產品型號 | JAI |
| Product function 產品功能 | finger injury fixation 手指受傷固定 |
| Product material 產品材質 | high-density resin board + cotton 高密度樹脂板+棉 |
| Specification 規格 | M |
| Color 顏色 | white 白色 |
| Part of use 使用部位 | fingers 手指 |
| Packing size 包裝尺寸 | 10.5*7.5*4cm |
| Package weight 包裝重量 | 19 g |



注意事項:

- ◆ 此產品為手指保護指套，請確保使用前諮詢醫師或相關醫護人員。
- ◆ 未成年人、無自理能力者、淺感覺減退者需在監護人看護下使用。
- ◆ 請正確使用該產品，避免因不當使用造成意外傷害。

Finger Joint Fixation Support

手指關節固定支撐

Model: JAJ

Features:

- It is made of high-grade OK composite material and aluminum alloy sheet
- Good air permeability, light quality and high strength
- High adhesive Velcro, easy to fix, adjustable tightness
- Suitable for: finger correction, fracture and sprain, postoperative fixation, etc
- 由高檔OK複合材料和鋁合金板材衝壓製造
- 透氣性好、品質輕、强度高
- 高粘魔术貼，輕鬆固定，鬆緊可調
- 適用於：手指矯正、骨折扭傷、術後固定等需求



Specifications

| | |
|-------------------------------------|---|
| Product model 產品型號 | JAJ |
| Product function 產品功能 | finger injury fixation 手指受傷固定 |
| Product material 產品材質 | OK cloth + aluminum alloy strip OK布+鋁合金條 |
| Specification 規格 | free size 均碼 |
| Color 顏色 | royal blue 寶藍色 |
| Part of use 使用部位 | finger bone 手指骨 |
| Adjustable finger length 手指可調節長度 | 12cm |
| Adjustable palm length 手掌可調節長度 | 26.5cm |
| Packing size 包裝尺寸 | 10.5*7.5*4cm |
| Package weight 包裝重量 | 22 g |



注意事項:

- ◆ 根據自己的需求調節大小即可。
- ◆ 此產品為手腕保護指套，請確保使用前諮詢醫師或相關醫護人員。
- ◆ 請正確使用該產品，避免因不當使用造成意外傷害。

Double Finger Correction Fixed Splint

雙手指矯正固定夾板 Model: JAK

Features:

- It is made of high-grade OK composite material and aluminum alloy sheet
- Easy to use, beautiful appearance, good air permeability, light weight and high strength
- High sticky Velcro, easy to fix, adjustable, any finger can use
- Suitable for: finger correction, fracture and sprain, postoperative fixation, etc

- 由高檔OK復合材料和鋁合金板材沖壓製造
- 使用簡單方便、外型美觀、透氣性好、質量輕、強度高
- 高粘魔术貼，輕鬆固定，鬆緊可調，任何手指都可以使用
- 適用於：手指矯正、骨折扭傷、術後固定等需求



Specifications

| | |
|-------------------------------------|---|
| Product model 產品型號 | JAK |
| Product function 產品功能 | finger injury fixation 手指受傷固定 |
| Product material 產品材質 | OK cloth + aluminum alloy strip OK布+鋁合金條 |
| Specification 規格 | free size 均碼 |
| Color 顏色 | royal blue 寶藍色 |
| Part of use 使用部位 | fingers 手指 |
| Adjustable finger length 手指可調節長度 | 12cm |
| Adjustable wrist length 手腕可調節長度 | 24cm |
| Packing size 包裝尺寸 | 23.5*10*7cm |
| Package weight 包裝重量 | 92 g |

注意事項:

- ◆ 根據自己需求調節手指和腕部所需大小即可。
- ◆ 此產品為手腕保護指套，請確保使用前諮詢醫師或相關醫護人員。
- ◆ 請正確使用該產品，避免因不當使用造成意外傷害。



Injured Phalanx Fixator

受傷指骨固定器 Model: JAM

Features:

- It is made of high-grade OK composite material and aluminum alloy sheet
- Easy to use, beautiful appearance, good air permeability, light weight and high strength
- High sticky Velcro, easy to fix, adjustable, any finger can use
- Suitable for: finger correction, fracture and sprain, postoperative fixation, etc

- 由高檔OK復合材料和鋁合金板材沖壓製造
- 使用簡單方便、外型美觀、透氣性好、質量輕、強度高
- 高粘魔術貼，輕鬆固定，鬆緊可調，任何手指都可以使用
- 適用於：手指矯正、骨折扭傷、術後固定等需求



Specifications

| | |
|-------------------------------------|--|
| Product model 產品型號 | JAM |
| Product function 產品功能 | finger injury fixation 手指受傷固定 |
| Product material 產品材質 | ok cloth, cotton cloth, bendable metal strip ok布、棉布、可彎曲金屬條 |
| Model 型號 | free size 均碼 |
| Color 顏色 | royal blue 寶藍色 |
| Part of use 使用部位 | fingers 手指 |
| Adjustable finger length 手指可調節長度 | 12cm |
| Packing size 包裝尺寸 | 10.5*7.5*4cm |
| Package weight 包裝重量 | 20 g |



注意事項:

- ◆ 根據自己的需求調節大小即可。
- ◆ 此產品為手腕保護指套，請確保使用前諮詢醫師或相關醫護人員。
- ◆ 請正確使用該產品，避免因不當使用造成意外傷害。

Breathable Finger Injury Fixator

透气手指受傷固定器

Model: SU

Features:

- It is made of high-grade OK composite material and aluminum alloy sheet
- Easy to use, beautiful appearance, good air permeability, light weight and high strength
- High sticky Velcro, easy to fix, adjustable, any finger can use
- Suitable for: finger correction, fracture and sprain, postoperative fixation, etc
- 由高檔OK復合材料和鋁合金板材沖壓製造
- 使用簡單方便、外型美觀、透氣性好、質量輕、強度高
- 高粘魔術貼，輕鬆固定，鬆緊可調，任何手指都可以使用
- 適用於：手指矯正、骨折扭傷、術後固定等需求



Specifications

| | |
|-------------------------------------|--|
| Product model 產品型號 | SU |
| Product function 產品功能 | finger injury fixation 手指受傷固定 |
| Product material 產品材質 | OK cloth, cotton cloth, bendable metal strip OK布、棉布、可彎曲金屬條 |
| Model 型號 | free size for adults 成人均碼 |
| Color 顏色 | skin tone 膚色 |
| Part of use 使用部位 | fingers 手指 |
| Adjustable finger length 手指可調節長度 | 12cm |
| Packing size 包裝尺寸 | 10.5*7.5*4cm |
| Package weight 包裝重量 | 20 g |



注意事項:

- ◆ 根據自己的需求調節大小即可。
- ◆ 此產品為手指保護指套，請確保使用前諮詢醫師或相關醫護人員。
- ◆ 請正確使用該產品，避免因不當使用造成意外傷害。

Children's Breathable Finger Protector

兒童透氣手指護具

Model: SV

Features:

- It is made of high-grade OK composite material and aluminum alloy sheet
- Easy to use, beautiful appearance, good air permeability, light weight and high strength
- High sticky Velcro, easy to fix, adjustable, any finger can use
- Suitable for: finger correction, fracture and sprain, postoperative fixation, etc
- 由高檔OK復合材料和鋁合金板材沖壓製造
- 使用簡單方便、外型美觀、透氣性好、質量輕、強度高
- 高粘魔术貼，輕鬆固定，鬆緊可調，任何手指都可以使用
- 適用於：手指矯正、骨折扭傷、術後固定等需求



Specifications

| | |
|-------------------------------------|--|
| Product model 產品型號 | SV |
| Product function 產品功能 | finger injury fixation 手指受傷固定 |
| Product material 產品材質 | OK cloth, cotton cloth, bendable metal strip OK布、棉布、可彎曲金屬條 |
| Model 型號 | free size 均碼 |
| Color 顏色 | black 黑色 |
| Part of use 使用部位 | fingers 手指 |
| Adjustable finger length 手指可調節長度 | 10cm |
| Packing size 包裝尺寸 | 10.5*7.5*4cm |
| Package weight 包裝重量 | 17 g |

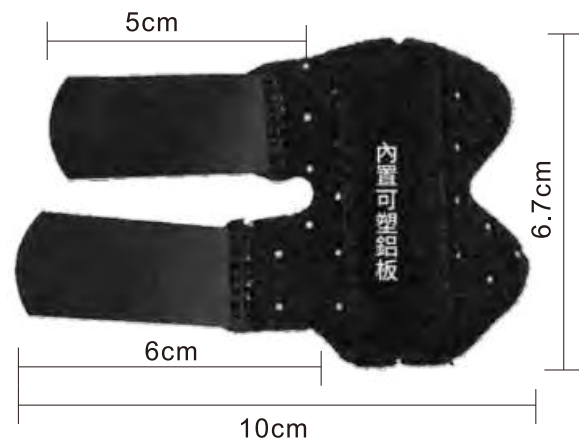

注意事項:

- ◆ 根據自己的需求調節大小即可。
- ◆ 此產品為手指保護指套，請確保使用前諮詢醫師或相關醫護人員。
- ◆ 請正確使用該產品，避免因不當使用造成意外傷害。

Wrist Sprain Fixation Belt

腕關節手腕扭傷固定帶

Model: JG

Features:

- Artificial curve design, strengthen fixation, double protection
 - High adhesive Velcro, easy to fix, adjustable tightness
 - Strengthen the double fixation belt, so that the injured hand secondary protection, promote hand rehabilitation
 - Lightweight fabric for comfort and breathability
 - Suitable for: hand and wrist injuries, hand rehabilitation and other hand rehabilitation use
- 人工學曲線設計, 加強固定, 雙重保護
 - 高粘魔術貼, 輕鬆固定, 鬆緊可調
 - 加固雙重固定帶, 讓受傷的手二次保護, 促進手部康復
 - 輕薄面料, 舒適透氣
 - 適用於: 手部手腕受傷、手部復健等手部康復使用



Specifications

| | |
|-------------------------------|------------------------------------|
| Product model 產品型號 | JG |
| Product function 產品功能 | wrist injury fixation 手腕受傷固定 |
| Product material 產品材質 | composite cloth 複合布 |
| Specification 規格 | S M L XL |
| Color 顏色 | blue 藍色 |
| Applicable parts 適用部位 | left hand, right hand 左手、右手 |
| Applicable arm size 適用手臂尺寸 | 17-23cm, 19-25cm, 21-27cm, 23-29cm |
| Product weight 產品重量 | 70g, 74g, 76g, 82g |
| Packing size 包裝尺寸 | 25.5*20*7cm |
| Package weight 包裝重量 | 0.19kg, 0.20kg, 0.20kg, 0.21kg |



注意事項:

- ◆ 根據自己需求調節手指和腕部所需大小即可。
- ◆ 此產品為手腕保護指套, 請確保使用前諮詢醫師或相關醫護人員。
- ◆ 請正確使用該產品, 避免因不當使用造成意外傷害。

Wrist Joint Fixed Support With Steel Plate

帶鋼板腕關節固定支撐

Model: JF

Features:

- Not easy to deform, durable, fine stitching and guaranteed quality
 - Breathable sponge fabric, soft skin, pore design, breathable and sweat free
 - Open adjustable design, free adjustment, easy to wear
 - High quality Velcro, easy to pull, firm and adjustable, can not be stuck for many times, good wrapping
 - Suitable for: hand wrist injury, hand rehabilitation, etc
-
- 不易變形, 持久耐用, 縫線精細, 品質有保證
 - 透氣海綿面料, 柔軟親膚, 孔狀設計透氣不悶汗
 - 開放式可以調節設計, 自由調節, 方便穿戴
 - 高質量魔术貼, 易拉牢固可調節, 多次粘貼不起球, 包裹性好
 - 適用於: 手部手腕受傷、手部復健等



Specifications

| | |
|------------------------|---------------------------------|
| Product model 產品型號 | JF |
| Product function 產品功能 | wrist injury fixation 手腕受傷固定 |
| Product material 產品材質 | composite cloth 複合布 |
| Specification 規格 | S M L |
| Color 顏色 | gray 灰色 |
| Applicable parts 適用部位 | left hand, right hand 左手、右手 |
| Arm circumference 適用臂圍 | 24-38cm, 28-41cm, 30-43cm |
| Packing size 包裝尺寸 | 25.5*20*7cm |
| Package weight 包裝重量 | 0.21kg, 0.22kg, 0.23kg |



注意事項:

- ◆ 根據自己需求調節手指和腕部所需大小即可。
- ◆ 此產品為手腕保護指套, 請確保使用前諮詢醫師或相關醫護人員。
- ◆ 請正確使用該產品, 避免因不當使用造成意外傷害。

Fixed Protector For Thumb Sprain

大拇指扭傷固定護具

Model: JH

Features:

- Artificial curve design, strengthened fixation, double protection
 - High-adhesive Velcro, easy to fix, adjustable elasticity, no longer worry about finger thickness and wrist size, easy to wear
 - Lightweight fabric, comfortable and breathable
 - Suitable for: tenosynovitis, thumb injury, use during exercise
- 人工學曲線設計, 加強固定, 雙重保護
 - 高粘魔術貼, 輕鬆固定, 鬆緊可調, 不再為手指粗細和手腕大小而煩惱, 穿戴方便
 - 輕薄面料, 舒適透氣
 - 適用於: 腱鞘炎、拇指受傷、運動時使用



Specifications

| | |
|---|---------------------------------|
| Product model 產品型號 | JH |
| Product function 產品功能 | wrist injury fixation 手腕受傷固定 |
| Product material 產品材質 | composite cloth 複合布 |
| Specification 規格 | S M L |
| Color 顏色 | royal blue 寶藍色 |
| Applicable parts 適用部位 | left hand, right hand 左手、右手 |
| The longest stretchable Wristband 腕帶最長可拉伸 | 28cm ,30cm , 32cm |
| Packing size 包裝尺寸 | 15.5*15*4.5cm |
| Package weight 包裝重量 | 87g , 90g , 95g |



注意事項:

- ◆ 根據自己需求調節手指和腕部所需大小即可。
- ◆ 此產品為手腕保護指套, 請確保使用前諮詢醫師或相關醫護人員。
- ◆ 請正確使用該產品, 避免因不當使用造成意外傷害。

Children's Thumb Fixed Protective Sleeve

兒童大拇指固定保護套

Model: KJ

Features:

- Built-in aluminum alloy steel plate thumb fixed support healthy exercise
- Skin-friendly, warm, lightweight, reduce finger weight, lightweight, comfortable fabric
- The Velcro can be adjusted freely. The Velcro design can be adjusted freely
- Suitable for: thumb injury, thumb valgus, wrist injury, etc.
- 內置鋁合金鋼板大拇指固定支撐健康運動
- 親膚保暖輕便減少護指重量輕便面料舒適
- 魔术貼自由調節魔术貼設計可以自由調節
- 適用於：拇指受傷、拇指外翻、手腕受傷等



Specifications

| | |
|-----------------------|---|
| Product model 產品型號 | KJ |
| Product function 產品功能 | fingers and wrists are injured and fixed 手指,手腕受傷固定 |
| Product material 產品材質 | OK cloth on the front, T cloth on the back 正面OK布, 反面T布 |
| Specification 規格 | black L (student model 8~13 years old) 黑色L (學生款8~13岁) |
| Suitable for 適用於 | fingers, wrist 手指,手腕 |
| Product weight 適用尺寸 | 22cm finger: 9cm adjustable 手腕:22cm 手指:9cm 可调节 |
| Product weight 產品重量 | 13g |
| Packing size 包裝尺寸 | 12*12*5cm |
| Package weight 包裝重量 | 39g |



注意事項:

- ◆ 將產品帶在大拇指上根據自身調節拇指處固定和手腕處的鬆緊，合適為宜。
- ◆ 此產品為手腕保護指套，請確保使用前諮詢醫師或相關醫護人員。
- ◆ 請正確使用該產品，避免因不當使用造成意外傷害。

Finger Plate Finger Separator

手部分指板手指分離器

Model: JL

Features:

- The five fingers are separated and fixed to achieve the function of finger recovery
 - Artificial curve design, strengthened fixation, double protection
 - High-adhesive Velcro, easy to fix, adjustable elasticity, easy to wear
 - Suitable for: wrist injury, hand rehabilitation, etc
- 五指分開固定,達到分指恢復功效,左右手均可使用
 - 人工學曲線設計,加強固定,雙重保護
 - 高粘魔術貼,輕鬆固定,鬆緊可調,穿戴方便
 - 適用於:手腕受傷、手部復健等



Specifications

| | |
|-----------------------|--|
| Product model 產品型號 | JL |
| Product function 產品功能 | finger separation and fixation 手指分離固定 |
| Product material 產品材質 | plastic + composite cloth 塑膠+複合布 |
| Color 顏色 | white 白色 |
| Specification 規格 | one size, left and right common 均碼,左右通用 |
| Product size 產品尺寸 | 17.5*24*1cm |
| Product weight 產品重量 | 97g |
| Packing size 包裝尺寸 | 25.5*20*7cm |
| Package weight 包裝重量 | 0.22kg |



注意事項:

- ◆ 取出產品,根據自己的需求調節大小,粘上魔術貼即可。
- ◆ 此產品為手指固定指套,請確保使用前諮詢醫師或相關醫護人員。
- ◆ 請正確使用該產品,避免因不當使用造成意外傷害。

Adjustable Finger Injury Fixation Splint

可調節手指受傷固定夾板

Model: JBQ

Features:

- The whole pulling rope is fixed and can be adjusted according to its own situation
- Soft rubber lining, soft and not hurt hands
Suitable for: finger correction, fracture and sprain, postoperative fixation, etc
- 拉繩固定, 整根拉繩固定, 可根據自身的情況調節
- 軟橡膠內襯, 柔軟不傷手
適用於: 手指矯正、骨折扭傷、術後固定等需求



Specifications

| | |
|-----------------------|----------------------------------|
| Product model 產品型號 | JBQ |
| Product function 產品功能 | finger injury fixation 手指受傷固定 |
| Product material 產品材質 | ABS+silica gel ABS+矽膠 |
| Specification 規格 | M size can be adjusted M號可調節 |
| Color 顏色 | grey 灰色 |
| Product weight 產品重量 | 13g |
| Product weight 產品尺寸 | 7.5*2.5*2.5cm |
| Packing size 包裝尺寸 | 10.5*7.5*4cm |
| Package weight 包裝重量 | 20g |



注意事項:

- ◆ 將手指放入夾板, 然後收緊拉繩即可調節鬆緊。
- ◆ 此產品為手指受傷固定或手指矯正的護具, 請確保使用前諮詢醫師或相關醫護人員。
- ◆ 請正確使用該產品, 避免因不當使用造成意外傷害。

Hand Training Deformity Straightener

手部訓練畸形壓直器

Model: JBS

Features:

- The size can be adjusted freely to straighten the finger that can't be extended
- Soft and skin friendly material, comfortable to wear
- Fit the curve of healthy fingers and wear it for a long time without discomfort
- Suitable for: finger bending and fixation, finger correction, finger training, etc
- 大小可自由調節, 將伸不直的手指壓直
- 柔軟親膚材質, 佩戴舒適, 無刺激
- 人體工程學設計, 貼合健康手指曲線, 長時間佩戴無不適感
- 適用於: 手指彎曲固定、手指矯正、手指訓練等



Specifications

| | |
|-----------------------|-------------------------------------|
| Product model 產品型號 | JBS |
| Product function 產品功能 | finger bending correction 手指彎曲矯正 |
| Product material 產品材質 | aluminum alloy +silicone 鋁合金+矽膠 |
| Specification 規格 | M size can be adjusted M號可調節 |
| Color 顏色 | white 白色 |
| Product weight 產品重量 | 36g |
| Product weight 產品尺寸 | 8*7.5*2.8cm |
| Packing size 包裝尺寸 | 12*12*5cm |
| Package weight 包裝重量 | 54g |



注意事項:

- ◆ 調節加壓器螺絲漸進壓力, 將伸直不足的手指壓直。
- ◆ 此產品為手指矯正的護具, 請確保使用前諮詢醫師或相關醫護人員。
- ◆ 必須佩戴舒適, 並不影響血液循環為主。

Inflatable Wrist Strap

充氣式腕關節固定帶

Model: JDE

Features:

- Delicate binding, thumb button design, comfortable
- Buckle adjustment, easy to wear, one-hand adjustment of tightness, fast and easy to wear
- Towel cloth design, skin-friendly fabric, breathable design, sweat-absorbing and non-pilling
- 細膩包邊, 拇指扣設計, 舒適不勒手
- 卡扣調節, 輕鬆穿戴, 單手調鬆緊, 快捷易佩戴
- 毛巾佈設計, 親膚布料, 透氣款設計, 吸汗不起球



Specifications

| | |
|-----------------------|-----------------------|
| Product model 產品型號 | JDE |
| Product function 產品功能 | hand fixation 手部固定 |
| Product material 產品材質 | spandex+nylon 氨綸+尼龍 |
| Product weight 產品尺寸 | 165*175mm |
| Product weight 產品重量 | 72g |
| Packing size 包裝尺寸 | 15*15*5cm |
| Package weight 包裝重量 | 140g |



注意事項:

- ◆ 請確保使用前諮詢醫師或相關醫護人員。
- ◆ 請正確使用該產品, 避免因不當使用造成意外傷害

Hand Fracture Fixation Bandage

手部骨折固定綁帶

Model: JDX

Features:

- Securer fixation, not easy to detach
- Fabric is breathable and soft

- 固定更牢固, 不易脫離
- 面料透氣、柔軟



Specifications

| | |
|-----------------------|--------------------|
| Product model 產品型號 | JDX |
| Product function 產品功能 | hand fixation 手部固定 |
| Product material 產品材質 | OK cloth Ok布 |
| Color 顏色 | 黑色 |
| Product weight 產品尺寸 | 49*5.2cm |
| Product weight 產品重量 | 20g |
| Packing size 包裝尺寸 | 10*10*3cm |
| Package weight 包裝重量 | 0.05kg |

注意事項:

- ◆ 請勿使用金屬清潔球等尖銳物品進行清洗;
- ◆ 請勿長期置於高溫場所, 以免變形;
- ◆ 請勿接觸明火及腐蝕性液體。

Wrist Strap

手腕腳腕束縛帶

Model: JEA

Features:

- Composite fabric OK cloth, comfortable to use, soft and skin-friendly, thickened sponge, good breathability
- The bandage is lengthened and fixed freely. The length can reach 150cm. The fixation effect is good, and it can restrict the patient's limb movement very well
- The restraint sleeve is enlarged and widened, which is comfortable to use, and is suitable for most people
- 複合面料OK布, 使用舒適, 柔軟親膚, 加厚海綿, 透氣性好
- 綁帶加長, 自由固定, 長度可達150cm, 固定效果好, 能很好的限制病人的肢體活動
- 約束套加大加寬設計, 使用舒適, 不咯手腕、腳腕, 適合多數人群使用



Specifications

| | |
|-----------------------|--|
| Product model 產品型號 | JEA |
| Product function 產品功能 | fixation of wrist and ankle 手腕腳腕固定 |
| Product material 產品材質 | composite fabric 複合面料 |
| Specification 規格 | 2 wrists+2 ankles 手腕2只+腳腕2只 |
| Color 顏色 | blue 藍色 |
| Product weight 產品尺寸 | wrist: 27 * 10cm, ankle: 33 * 10.5cm 手腕:27*10cm, 腳腕:33*10.5cm |
| Product weight 產品重量 | 13g |
| Packing size 包裝尺寸 | 10.5*7.5*4cm |
| Package weight 包裝重量 | 20g |

注意事項:

- ◆ 請勿使用金屬清潔球等尖銳物品進行清洗;
- ◆ 請勿長期置於高溫場所, 以免變形;
- ◆ 請勿接觸明火及腐蝕性液體。

Front Open Restraint Gloves

前開式約束手套

Model: JEB

Features:

- Front end opening, convenient for inspection and measurement
- Mesh material, durable, comfortable and breathable, without pressure
- There is a splint inside to prevent gripping, and the reinforced lining plate is perforated and ventilated to prevent self-injury
- Widened velcro, nylon velcro, firm and not easy to break off
- Double-day ring design, comfortable and firm, uniform stress
- Suitable for: children, the elderly, the deaf and the unconscious
- 前端開口，檢查測量方便
- 網眼布材質，堅固耐用，舒適透氣，不會有壓迫感
- 內有夾板防抓握，強化襯板打孔透氣，防自傷
- 加寬魔术貼，尼龍魔术貼，牢固不易掙脫
- 雙日型環設計，舒適牢固，受力均勻
- 適合人群：兒童、老人、失聰人群無意識人群

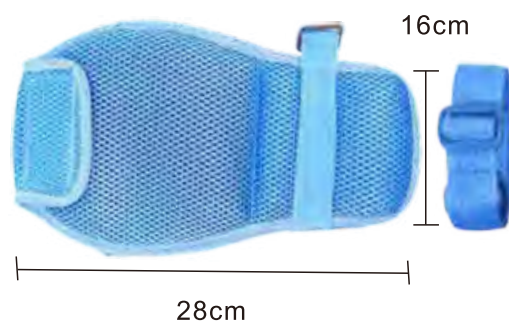

Specifications

| | |
|-----------------------|--|
| Product model 產品型號 | JEB |
| Product function 產品功能 | hand fixation 手部固定 |
| Product material 產品材質 | mesh, nylon strap 網眼布、尼龍綁帶 |
| Color 顏色 | blue 藍色 |
| Product weight 產品尺寸 | 16 * 28cm, with a length of about 80cm 16*28cm,綁帶長約80cm |
| Product weight 產品重量 | 92g |
| Packing size 包裝尺寸 | 25*17*5cm |
| Package weight 包裝重量 | 0.16kg |

注意事項:

- ◆ 請勿使用金屬清潔球等尖銳物品進行清洗；
- ◆ 請勿長期置於高溫場所，以免變形；
- ◆ 請勿接觸明火及腐蝕性液體。

Foam Roll Splint

泡沫卷式夾板

Model: JEC

Features:

- It is made of aluminum plate and foam material, which can be folded freely and has good plasticity
- Aluminum alloy metal plate can be bent into various shapes at will, and can be cut according to the user's situation
- Small size, light weight, easy to carry, washable, and wide application area
- 採用鋁板和泡沫材質結合，任意折疊，可塑性好
- 鋁合金金屬板，可隨意彎曲成各種形狀，可根據使用者的情況進行裁剪
- 體積小，重量輕，攜帶方便，可清洗，適用面積廣泛



Specifications

| | |
|-----------------------|---------------------------------------|
| Product model 產品型號 | JEC |
| Product function 產品功能 | fixation of wrist and ankle 手腕腳腕固定 |
| Product material 產品材質 | foam+aluminum plate 泡沫+鋁板 |
| Specification 規格 | 2 wrists+2 ankles 手腕2只+腳腕2只 |
| Color 顏色 | orange 橘色 |
| Product weight 產品尺寸 | 46x11cm |
| Product weight 產品重量 | 146g |
| Packing size 包裝尺寸 | 12*12*5cm |
| Package weight 包裝重量 | 0.17kg |



注意事項:

- ◆ 請勿使用金屬清潔球等尖銳物品進行清洗；
- ◆ 請勿長期置於高溫場所，以免變形；
- ◆ 請勿接觸明火及腐蝕性液體。

Rest Position Finger Board

休息位分指板

Model: JEN/JEN2

Features:

- The curved design of the board conforms to ergonomics and can be worn when sleeping
 - Plenty of perforations, no sweat, comfortable to wear for a long time
 - Three adhesive tapes are made of soft material, which will not hurt hands if worn for a long time
 - The board surface is made of ABS plastic material, which is durable and does not deform
- 板面弧形設計, 符合人體工學, 可睡覺時佩戴
 - 大量透氣孔設計, 不存汗水, 長時間佩戴舒適
 - 三根粘帶材質柔軟, 長時間佩戴不傷手
 - 板面採用ABS塑膠材質, 結實耐用, 不變形

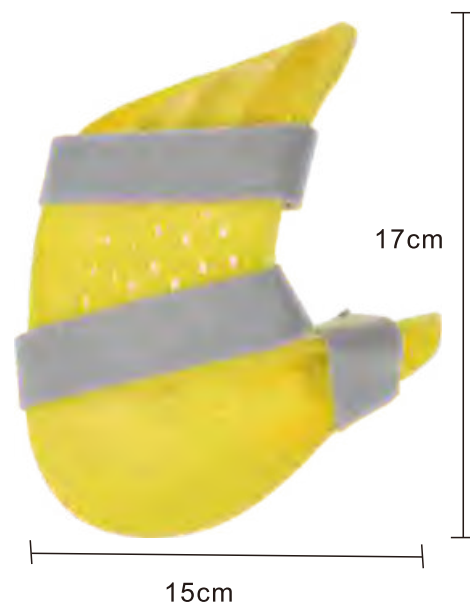

Specifications

| | |
|-----------------------|--|
| Product model 產品型號 | JEN/JEN2 |
| Product function 產品功能 | hand fixation 手部固定 |
| Product material 產品材質 | ABS panel+soft adhesive tape ABS板面+柔軟粘帶 |
| Color 顏色 | yellow 黃色 |
| Specifications 規格 | one size left/right 均碼 左手/右手 |
| Product weight 產品尺寸 | 17*15*7cm |
| Product weight 產品重量 | 70g |
| Packing size 包裝尺寸 | 25*20*7cm |
| Package weight 包裝重量 | 0.18kg |



注意事項:

- ◆ 請勿使用金屬清潔球等尖銳物品進行清洗;
- ◆ 請勿長期置於高溫場所, 以免變形;
- ◆ 請勿接觸明火及腐蝕性液體。

Two-in-one Anti-hook Wrist Corrector

二合一防勾腕矯正器

Model: JET

Features:

- Skin-friendly breathable, comfortable to wear, breathable fabric, avoiding stuffiness
- Corrected wrist hook, scientific grip, adjustable length
- Lightweight and washable, portable for business travel, and washable fabric
- 親膚透氣, 穿戴舒爽, 透氣面料, 拒絕悶熱
- 矯正勾腕, 科學握姿, 長短可伸縮調節
- 輕巧攜帶可清洗, 出差旅行可攜帶, 面料可水洗



Specifications

| | |
|-----------------------|-------------------------|
| Product model 產品型號 | JET |
| Product function 產品功能 | wrist lock 手腕固定 |
| Product material 產品材質 | nylon 尼龍 |
| Specification 規格 | one size fits all 均碼 |
| Product weight 產品尺寸 | 23*20cm |
| Product weight 產品重量 | 23g |
| Packing size 包裝尺寸 | 10*10*3cm |
| Package weight 包裝重量 | 0.05kg |



注意事項:

- ◆ 請勿使用金屬清潔球等尖銳物品進行清洗;
- ◆ 請勿長期置於高溫場所, 以免變形;
- ◆ 請勿接觸明火及腐蝕性液體。

Magnetic Therapy Silicone Wrist Guard

磁療矽膠護腕套

Model: JEV

Features:

- Convenient to wear, comfortable fit, free movement, joint care, soft and skin-friendly
 - Soft Q-elastic, comfortable to wear, 24 hours wearable magnetic therapy wrist strap
 - Human body mechanical design, with good stability and aging resistance, weather resistance, heat resistance, high elasticity, etc
- 便捷佩戴、舒適貼合、活動自如、呵護關節、柔軟親膚
 - 柔軟Q彈，穿戴舒適，24小時可穿戴磁療手腕套
 - 人體力學設計，具有良好的穩定性和耐老化性，耐候性、耐熱性、高彈性等



Specifications

| | |
|-----------------------|--|
| Product model 產品型號 | JEV |
| Product function 產品功能 | hand fixation to prevent mouse hands 手部固定，預防滑鼠手 |
| Product material 產品材質 | SEBS+magnetic therapy magnet SEBS+磁療磁鐵 |
| Color 顏色 | complexion 膚色 |
| Specifications 規格 | one size 均碼 |
| Product weight 產品尺寸 | 14*7.5cm |
| Product weight 產品重量 | 26g |
| Packing size 包裝尺寸 | 10*10*3cm |
| Package weight 包裝重量 | 0.05kg |

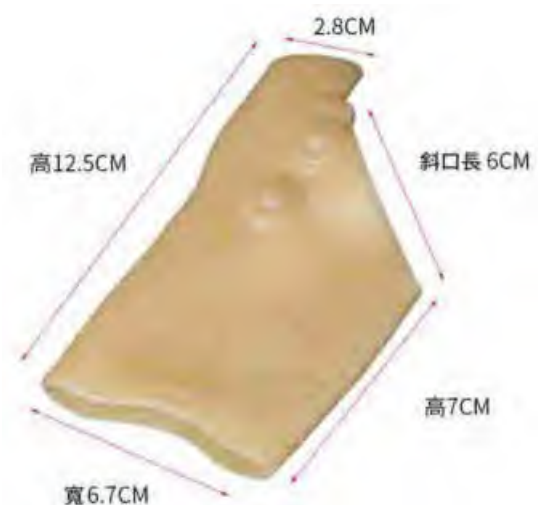

注意事項:

- ◆ 請勿使用金屬清潔球等尖銳物品進行清洗；
- ◆ 請勿長期置於高溫場所，以免變形；
- ◆ 請勿接觸明火及腐蝕性液體。



Leg Joint Traction Device

腿部牽引

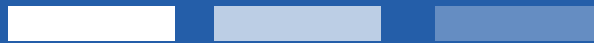

Hip Orthosis Traction Device

髖關節矯形牽引器

Model: JX

Features:

- For left and right
- Metal toothed disc, adjustable chuck can control and fix the range of motion of hip joint
- The metal bracket makes the whole orthosis structure stronger
- Adjustable length, suitable for people of different heights
- Applicable to:
 - Fixation before and after hip surgery, fixation of fracture or dislocation,
 - Pain relief and walking aid for degenerative degree of hip joint
- 適用於左右兩側
- 金屬齒盤, 調整卡盤可控制及固定髖關節之活動範圍
- 金屬支架使整個矯形器結構更加堅固
- 調整螺絲位置, 可調節長短, 適應不同身高者使用
- 適用於:
 - 髖關節手術前、後的固定, 骨折或脫臼的固定,
 - 髖關節退化性度的止疼, 助行

Specifications

| | |
|-----------------------|--|
| Product model 產品型號 | JX |
| Product function 產品功能 | fixation of knee joint 膝關節固定 |
| Product material 產品材質 | polyurethane + ABS+alloy 聚氨酯+ABS+合金 |
| Fitting 貼合物 | 100% polyurethane 100%聚氨酯 |
| Specification 規格 | free size 均碼 |
| Suitable for 適用於 | waist circumference: 80-120cm leg circumference: 50-70cm 適用腰圍: 80-120cm 適用腿圍: 50-70cm |
| Product size 產品尺寸 | 46*27*8cm |
| Product weight 產品重量 | 830g |
| Package weight 包裝重量 | 43*21*27cm |
| Packing size 包裝尺寸 | 0.83kg |



注意事項:

- ◆ 將固定器上部固定於腰部, 側板位於患肢外側固定器下縛帶固定於大腿。
- ◆ 調整螺絲位置, 可調節固定器長短以適合固定患肢為宜。
- ◆ 用配套的螺絲刀(六稜)調節卡盤, 跟據醫囑限定髖關節活動範圍。
- ◆ 未成年人、無自理能力者、淺感覺減退者需在監護人幫助下使用。
- ◆ 諮詢專業人士正確使用產品。
- ◆ 凝血機制障礙、血管脆性增高及精神心理有障礙者不建議使用。
- ◆ 此產品佩戴應鬆緊適度, 佩戴後如病情無明顯改善, 請及時諮詢醫生或相關專業人員。

Far Infrared Kneepad

遠紅外護膝

Model: JY

Features:

- Provide warmth and support to prevent sports and work injuries
- It is woven with high elastic fiber, the structure is breathable, and it is not easy to slip
- Applicable to:
Knee joint swelling, acute and chronic injury of the tissues around the knee joint expansion, knee joint instability
Old knee injury, rheumatic pain, etc.
- 提供保暖與支撐, 預防運動和工作創傷
- 使用高彈纖維織造, 結構透氣, 不易滑脫。
- 適用於:
膝關節腫脹、膝關節擴周圍組織的急性慢性損傷、膝關節不穩
膝關節陳舊性損傷、風濕疼痛等



Specifications

| | |
|---------------------------|--|
| Product Model 產品型號 | JY |
| Product Function 產品功能 | knee protection 膝關節保護 |
| Product Material 產品材質 | 40% polyamide, 30% polyester, 20% styrene butadiene rubber, 10% far infrared powder 40% 聚醯胺, 30% 聚酯, 20% 丁苯橡膠, 10% 遠紅外粉 |
| Leg Circumference 適用腿圍 | S : 36-39cm M : 39-43cm L : 43-47cm |
| Suitable For 適用於 | for left and right feet 左右腳通用 |
| Washing Instructions 洗滌說明 | hand wash, hang to dry 可手洗, 懸掛晾乾 |
| Product Weight 產品重量 | 64g |
| Packing Size 包裝尺寸 | 21*13*5cm |
| Package Weight 包裝重量 | 0.11kg |



注意事項:

- ◆ 將產品取出穿戴在膝蓋處即可。
- ◆ 未成年人、無自理能力者、淺感覺減退者需在監護人幫助下使用。
- ◆ 凝血機制嚴重障礙者、心理障礙者、精神疾病者不建議使用。
- ◆ 對於皮膚不耐熱或敏感(壓力)的患者慎用。
- ◆ 此產品佩戴應鬆緊適度, 佩戴後如病情無明顯改善, 請及時諮詢醫生或相關專業人員。

Open Knee Joint Fixator

開放式膝關節固定器

Model: JZ

Features:

- Open design, perforated neoprene fabric for warmth and ventilation
 - Bionic double axis hinge on both sides, in line with ergonomics, protect ligaments and stabilize knee joint
 - Applicable to:
It can also provide support for patellar instability, subluxation and dislocation collateral ligament injury.
- 開放式設計, 沖孔NEOPRENE面料, 保暖透氣
 - 兩側仿生雙軸鉸鏈, 符合人體工學, 保護韌帶, 穩定膝關節
 - 適用於:
主要用於急性輕度至重度膝部疼痛者使用, 亦可對髌骨不穩定, 髌骨半脫位及脫位提供支撐側副韌帶損傷



Specifications

| | |
|---------------------------|---|
| Product model 產品型號 | JZ |
| Product function 產品功能 | fixation of knee joint 膝關節固定 |
| Product material 產品材質 | 50% polyamide, 40% styrene butadiene rubber, 10% polyester fiber 50% 聚醯胺, 40% 丁苯橡膠, 10% 聚酯纖維 |
| Fitting 支條 | 100% aluminum 100% 鋁 |
| Leg Circumference 適用腿圍 | S : 39-49cm M : 47-53cm L : 53-60cm |
| Suitable for 適用於 | for left and right feet 左右腳通用 |
| Washing Instructions 洗滌說明 | hand wash, hang to dry 可手洗, 懸掛晾乾 |
| Product weight 產品重量 | 280g |
| Packing size 包裝尺寸 | 28.5*13*8.5cm |
| Package weight 包裝重量 | 0.37kg |



注意事項:

- ◆ 從膝蓋後側圍裹至前側, 後側開孔對準髌窩高位置, 前側開孔對準髌骨位置, 將魔术貼互相粘接。
- ◆ 收緊大腿與小腿的綁帶, 以護膝不滑脫為宜。
- ◆ 未成年人、無自理能力者、淺感覺減退者需在監護人幫助下使用。
- ◆ 諮詢專業人士正確使用產品。
- ◆ 凝血機制障礙、血管脆性增高及精神心理有障礙者不建議使用。
- ◆ 此產品佩戴應鬆緊適度, 佩戴後如病情無明顯改善, 請及時諮詢醫生或相關專業人員。

Three Piece Knee Joint Fixator

三片式膝關節固定器

Model: JAW

Features:

- High strength aluminum alloy brace, strong fixed knee joint in extension position
- Three piece design, suitable for people of different statures
- Applicable to:
Fixation of tibial plateau fracture, distal femur fracture, proximal fibula fracture, or ligament injury of knee joint before and after operation
It can replace plaster or splint (it should be used under the guidance of a specialist)
- 高強度鋁合金支條，強力固定膝關節在伸直位
- 三片式設計，適用於不同身材人群
- 適用於：
脛骨平臺骨折、股骨遠端骨折、腓骨近端骨折，或膝關節各個韌帶損傷手術前後的固定
可以代替石膏或夾板（應在專科醫生指導下使用）



Specifications

| | |
|---------------------------|---|
| Product model 產品型號 | JAW |
| Product function 產品功能 | fixation of knee joint 膝關節固定 |
| Product material 產品材質 | 50% polyester fiber 40% polyurethane 10% polyamide 50% 聚酯纖維 40% 聚氨酯 10% 聚醯胺 |
| Fitting 支條 | 100% aluminum 100% 鋁 |
| Leg Circumference 適用腿圍 | S : 36-39cm M : 39-43cm L : 43-47cm |
| Suitable for 適用於 | for left and right feet 左右腳通用 |
| Washing instructions 洗滌說明 | hand wash, hang to dry 可手洗，懸掛晾乾 |
| Product weight 產品重量 | 645g |
| Packing size 包裝尺寸 | 53*23*29cm |
| Package weight 包裝重量 | 1.25kg |



注意事項:

- ◆ 將患腿置於中片上，膝關節對準開孔：合上襯墊，粘貼固定鬆緊程度以完全限制膝關節屈伸為宜。
- ◆ 繼續粘貼外圍綁帶，加強固定。
- ◆ 未成年人、無自理能力者、淺感覺減退者需在監護人幫助下使用。
- ◆ 諮詢專業人士正確使用產品。
- ◆ 凝血機制障礙、血管脆性增高及精神心理有障礙者不建議使用。
- ◆ 此產品佩戴應鬆緊適度，佩戴後如病情無明顯改善，請及時諮詢醫生或相關專業人員。

Portable Knee Joint Limit Fixation Tractor

輕便膝關節限位固定牽引器

Model: JAX

Features:

- Turntable design, every ten degrees can set the buckling angle
- Breathable fabric, light and not easy to slip
- Opening design, easy to wear
- Applicable to:
Treatment of knee ligament strain and tear
Fixation and rehabilitation exercise after knee surgery (under the guidance of doctors)
- 轉盤設計, 每十度可以設定屈曲角度
- 透氣面料, 輕便不易滑脫
- 開口設計, 方便穿戴
- 適用於:
治療膝關節韌帶拉傷, 撕裂
膝關節術後, 關節鏡手術後的固定和康復鍛煉 (應在專科醫生指導下使用)



Specifications

| | |
|---------------------------|---|
| Product model 產品型號 | JAX |
| Product function 產品功能 | fixation of knee joint 膝關節固定 |
| Product material 產品材質 | 50% polyester fiber 40% polyurethane 10% polyamide 50% 聚酯纖維 40% 聚氨酯 10% 聚醯胺 |
| Fitting 支條 | 100% aluminum 100% 鋁 |
| Leg Circumference 適用腿圍 | S : 39-49cm L : 53-60cm |
| Suitable for 適用於 | for left and right feet 左右腳通用 |
| Washing Instructions 洗滌說明 | hand wash, hang to dry 可手洗, 懸掛晾乾 |
| Product weight 產品重量 | 430g |
| Packing size 包裝尺寸 | 36*24*20cm |
| Package weight 包裝重量 | 0.73kg |



注意事項:

- ◆ 刻度盤調整方法按下刻度盤兩側轉子的中間按鈕, 可依照患者需求, 調整合適的角度, 放開後即可穩定。
- ◆ 按鈕兩側有安全的保護裝置, 防止按鈕受碰撞而改變固定器角度。
- ◆ 未成年人、無自理能力者、淺感覺減退者需在監護人幫助下使用。
- ◆ 諮詢專業人士正確使用產品, 不可擅自更改結構設計或預設角度, 定期檢查矯形器效能。
- ◆ 此產品佩戴應鬆緊適度, 佩戴後如病情無明顯改善, 請及時諮詢醫生或相關專業人員。

O-type Leg Orthosis

O型腿矯正器

Model: JAZ

Features:

- Adjust the Velcro according to the leg type
- Thigh belt, knee belt, calf belt are widened and thicker, move, fall off
- The aluminum plate supports and fits the leg, and the strength is concentrated on both sides of the leg
- Both sides of the built-in imitation leg PVC thermoplastic version, fit the leg, force dispersion, scientific correction
- Remote control automatic pressure, no restriction on blood circulation, to avoid paralysis
- Applicable to: people who need leg correction
- 魔术贴可根据腿型调整大小反复粘粘, 不易脱落
- 三带合一全面覆盖大腿带、膝带、小腿带
- 铝板支撑贴合腿部两侧, 力量集中于腿部两侧
- 两侧内置仿腿型PVC热塑版, 高度贴合腿部轮廓, 受力分散, 矫正更科学
- 遥控自动加压舒适矫正, 不限制血液迴圈, 避免麻痹感
- 適用於: 需要腿部矯正的人群



Specifications

| | |
|-----------------------|-----------------------------------|
| Product model 產品型號 | JAZ |
| Product function 產品功能 | correct the shape of the leg 腿部矯正 |
| Product material 產品材質 | polyester fiber, spandex 聚酯纖維, 氨綸 |
| Voltage 電壓 | 12V/2A |
| Power 主機功率 | 24W/50/60Hz |
| Power 發熱功率 | 10W |
| Power 模式 | two modes 兩種模式可換 |
| Power 力度 | 9 levels 9種力度可調節 |
| Suitable for 適用於 | calf 30-55cm, thigh 40-78cm |
| Product size 產品尺寸 | 35*46cm |
| Product size 主機尺寸 | 15*14.5*5.5cm |
| Product weight 產品重量 | 958g |
| Packing size 包裝尺寸 | 45.5*19.5*13cm |
| Package weight 包裝重量 | 1.31kg |



注意事項:

- ◆ 剛開始使用不要綁太緊, 能感到壓迫感即可, 循序漸進的加大捆綁力度。
- ◆ 使用中不要起身或者走動。
- ◆ 妊娠期禁止使用本產品。

Adjustable Leg Fixed Bracket

可調節腿部固定支架

Model: JBU

Features:

- Adjustable chuck, gradual recovery angle adjustment, simple and convenient, can walk and exercise
 - Multiple non-slip straps + high-viscosity Velcro, tightly integrated with the legs, loose and adjustable
 - Suitable for: leg injuries, knee injuries, ligament strains, leg corrections, etc.
- 可調節卡盤, 漸進式恢復角度調節, 簡單方便, 可行走鍛煉
 - 多條防滑綁帶+高粘魔術貼, 與腿部緊密結合, 寬鬆可調
 - 適用於: 腿部受傷、膝蓋受傷、韌帶拉傷、腿部矯形等



Specifications

| | |
|-----------------------|---|
| Product model 產品型號 | JBU |
| Product function 產品功能 | fixed leg support 腿部固定支撐 |
| Material 材質 | aluminum alloy + sponge pad 鋁合金+海綿墊 |
| Mode 模式 | adjustable 可調節 |
| Model 型號 | left M 左M |
| Suitable for 適合尺寸 | thigh circumference 48-70cm calf circumference 37-50cm 大腿圍 48-70cm 小腿圍37-50cm |
| Product size 產品尺寸 | 56*22*10cm |
| Product weight 產品重量 | 1050g |
| Package size 包裝尺寸 | 59.5*15*15cm |
| Package weight 包裝重量 | 1.34kg |



注意事項:

- ◆ 使用前請諮詢醫護人員, 最好由醫護人員或者看護人幫助固定。
- ◆ 建議先固定好支具後, 再調節角度, 這樣不易牽動傷口。
- ◆ 固定綁帶時, 注意不要太緊或太鬆, 太緊影響血液循環, 太鬆護具沒有作用。

Adjustable Knee Brace

可調膝關節支架

Model: JBV

Features:

- Adjustable chuck, gradual recovery angle adjustment, simple and convenient, can walk and exercise
 - Multiple non-slip straps + high-viscosity Velcro, tightly integrated with the legs, loose and adjustable
 - Comfortable non-slip lining, not easy to fall off when worn
 - Suitable for: knee joint injuries and rehabilitation exercises
- 可調節卡盤，漸進式恢復角度調節，簡單方便，可行走鍛煉
 - 多條防滑綁帶+高粘魔術貼，與腿部緊密結合，寬鬆可調
 - 舒適防滑內襯，穿戴不易脫落
 - 適用於：膝關節部位受傷和康復鍛煉



Specifications

| | |
|-----------------------|--|
| Product model 產品型號 | JBV |
| Product function 產品功能 | fixed leg support 腿部固定支撐 |
| Material 材質 | aluminum alloy + composite cloth 鋁合金+復合布 |
| Mode 模式 | adjustable 可調節 |
| Model 型號 | free size 均碼 |
| Suitable for 適合尺寸 | thigh circumference 49-65cm calf circumference 36-52cm 大腿圍 49-65cm 小腿圍 36-52cm |
| Product size 產品尺寸 | 56*29*5cm |
| Product weight 產品重量 | 933g |
| Package size 包裝尺寸 | 59.5*15*15cm |
| Package weight 包裝重量 | 1.30kg |

注意事項:

- ◆ 使用前請諮詢醫護人員，最好由醫護人員或者看護人幫助固定。
- ◆ 建議先固定好支具後，再調節角度，這樣不易牽動傷口。
- ◆ 固定綁帶時，注意不要太緊或太鬆，太緊影響血液循環，太鬆護具沒有作用。



Three Piece Knee Fixator With Strap

三片式背帶型膝關節固定支具

Model: JBX

Features:

- The strap design prevents sliding and strengthens the fixation, making it easy and comfortable to wear
- Lightweight fabric with double breathability, elastic tension straps, comfortable to wear
- High-adhesive Velcro, easy to adjust, fixed straps, not easy to fall off
- Delicate edging, meticulous stitching, soft and comfortable, without cutting hands
- Suitable for: knee injury and rehabilitation exercise
- 新增背帶設計, 防止下滑加強固定, 穿戴輕鬆舒適
- 輕盈面料雙層透氣, 彈性拉力綁帶, 穿戴舒適
- 高粘魔术貼, 輕鬆調節, 固定綁帶, 不易脫落
- 細緻包邊, 縫線縝密, 柔軟舒適, 不割手
- 適用於: 膝關節部位受傷和康復鍛煉

Specifications

| | |
|------------------------|---|
| Product model 產品型號 | JBX |
| Product function 產品功能 | fixed leg support 腿部固定支撐 |
| Material 材質 | breathable mesh + OK cloth OK布+魔术貼 |
| Mode 模式 | adjustable 可調節 |
| Model 型號 | left M 左M |
| Suitable for 適合尺寸 | leg circumference 35-80cm 腿圍 35-80cm |
| Applicable height 適用身高 | about 180cm |
| Product size 產品尺寸 | 60*80*2cm |
| Product weight 產品重量 | 492g |
| Package size 包裝尺寸 | 59.5*15*15cm |
| Package weight 包裝重量 | 1.00kg |

注意事項:

- ◆ 使用前請諮詢醫護人員, 最好由醫護人員或者看護人幫助固定。
- ◆ 建議先固定好支具後, 再調節角度, 這樣不易牽動傷口。
- ◆ 固定綁帶時, 注意不要太緊或太鬆, 太緊影響血液循環, 太鬆護具沒有作用。



Lower Limb Stretch Belt

下肢拉伸帶

Model: JBK

Features:

- Adopt one-piece molding design, Velcro straps, convenient and quick
- Lajin has multiple pulling points, freely control the pulling force
- Universal design for left and right feet to meet the needs of different patients
- Light weight, small size, less area, more convenient to carry
- Suitable for: rehabilitation training, fitness
- 本產品採用一體成型設計, 使用方便快捷
- 拉筋帶擁有多個提拉點, 自由控制提拉力度
- 採用左右腳通用設計, 滿足不同患者的需求
- 重量輕、體積小, 不占面積, 攜帶更方便
- 魔術貼綁帶, 穿戴更方便
- 適用於: 康復訓練, 健身



Specifications

| | |
|-----------------------|---|
| Product model 產品型號 | JBK |
| Product function 產品功能 | rehabilitation training / fitness 康復訓練健身 |
| Material 材質 | comfortable composite fabric 舒適復合面料 |
| Size 尺碼 | free size 均碼 |
| Colour 顏色 | black 黑色 |
| Product size 產品尺寸 | 26*13*2cm |
| Product weight 產品重量 | 115g |
| Package size 包裝尺寸 | 25.5*20*7cm |
| Package weight 包裝重量 | 0.27kg |



注意事項:

- ◆ 根據自身需求更換拉伸力度, 循序漸進的加大力度。
- ◆ 如果你發現過敏或不適, 請立即停止使用。
- ◆ 避免高溫環境, 遠離一切熱源。



Foot Fixing Supporter

足部固定支撐

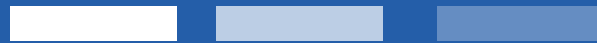

Talipes Valgus Fixator

大拇指外翻固定器

Model: JAN

Features:

- Side aluminum bar auxiliary support, humanized design, enhance comfort
- High-adhesive Velcro, easy to fix, adjustable elasticity, no longer worry about the thickness of the toes and the size of the instep
- Applicable to: needs such as valgus toe of thumb and toe injury, etc.
- 側面鋁條輔助支撐, 人性化設計, 提升舒適感
- 高粘魔術貼, 輕鬆固定, 鬆緊可調, 不再為腳趾粗細和腳背大小而煩惱
- 適用於: 大拇指腳趾外翻、腳趾受傷等需求



Specifications

| | |
|--|--|
| Product model 產品型號 | JAN |
| Product function 產品功能 | toe correction 腳趾矯正 |
| Product material 產品材質 | composite cloth + aluminum alloy strip 複合布+鋁合金條 |
| Color 顏色 | royal blue 寶藍色 |
| Specification 規格 | free size (left and right feet) 均碼(左右腳) |
| Suitable for 適用於 | adult 成人 |
| Adjustable toe length 腳趾可調節長度 | 15cm |
| Adjustable length of instep 腳背可調節長度 | 35cm |
| Packing size 包裝尺寸 | 15*15*5cm |
| Package weight 包裝重量 | 0.10kg |



注意事項:

- ◆ 根據自己的需求調節所需大小, 魔術貼粘接上即可。
- ◆ 此產品為腳趾保護指套, 請確保使用前諮詢醫師或相關醫護人員。
- ◆ 請正確使用該產品, 避免因不當使用造成意外傷害。

Foot And Thumb Valgus Fixation Strap

腳拇指外翻固定帶

Model: JU

Features:

- Toe correction: high stability, can be worn 24 hours, natural correction
- Folded foot width: OK cloth at the fitting part, soft filler to protect the big foot bone
- Reshaping the arch of the foot: reduce walking pain and remove thick cocoons on the sole of the foot
- Postoperative nursing: prevention of recurrence of hallux valgus
- Applicable to: toe correction, postoperative care, etc
- 腳趾矯正: 高穩固性, 可24小時佩戴, 自然矯正
- 收攏腳寬: 貼合部位OK布料, 填充物柔軟, 保護大腳骨
- 重塑足弓: 減少走路痛, 去除腳底厚繭
- 術後護理: 預防拇趾外翻復發
- 適用於: 腳趾矯正, 術後護理等



Specifications

| | |
|-----------------------|---|
| Product model 產品型號 | JU |
| Product function 產品功能 | toe correction 腳趾矯正 |
| Product material 產品材質 | composite fabric, PC support, metal buckle 複合面料, PC支架, 金屬扣 |
| Color 顏色 | white 白色 |
| Specification 規格 | all sizes can be adjusted 均碼可調節 |
| Suitable for 適用於 | adult 成人 |
| Product weight 產品重量 | 25g |
| Packing size 包裝尺寸 | 12*12*5cm |
| Package weight 包裝重量 | 52g |



注意事項:

- ◆ 根據自己的需求調節所需大小, 魔術貼粘接上即可。
- ◆ 此產品為腳趾保護指套, 請確保使用前諮詢醫師或相關醫護人員。
- ◆ 請正確使用該產品, 避免因不當使用造成意外傷害。

Inflatable Foot Protector

大拇指外翻固定器

Model: JDC

Features:

- Side aluminum strip support, humanized design, enhance comfort
- High-viscosity velcro, easy to fix, adjustable tightness, no longer worry about the size of toes and instep
- Applicable to: thumb and toe eversion, toe injury and other needs
- 側面鋁條輔助支撐，人性化設計，提升舒適感
- 高粘魔術貼，輕鬆固定，鬆緊可調，不再為腳趾粗細和腳背大小而煩惱
- 適用於：大拇指腳趾外翻、腳趾受傷等需求



Specifications

| | |
|-----------------------|--|
| Product model 產品型號 | JDC |
| Product function 產品功能 | toe fixed support 腳趾固定支撐 |
| Product material 產品材質 | composite cloth+aluminum alloy strip 複合布+鋁合金條 |
| Specifications 規格 | free size 均碼 |
| Color 顏色 | black 黑色 |
| Unfold size 展開尺寸 | 37*39cm |
| Product weight 產品重量 | 98g |
| Packing size 包裝尺寸 | 15*15*5cm |
| Package weight 包裝重量 | 102g |

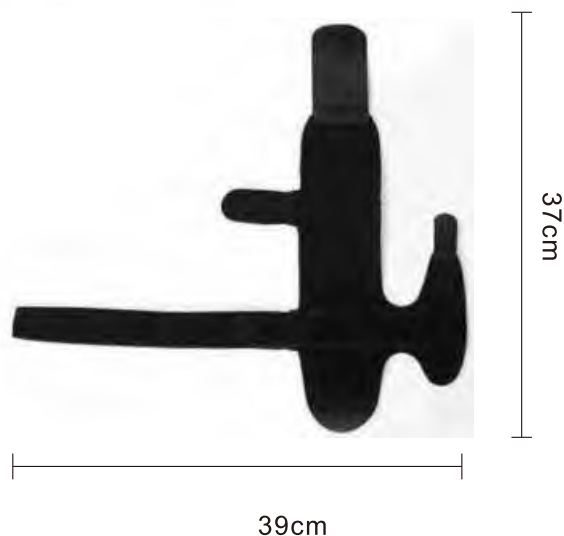

注意事項:

- ◆ 根據自己的需求調節所需大小，魔術貼粘接上即可。
- ◆ 此產品為腳趾保護指套，請確保使用前諮詢醫師或相關醫護人員。
- ◆ 請正確使用該產品，避免因不當使用造成意外傷害。

Split Toe Sleeve

分趾腳套

Model: JDQ

Features:

- Effectively separate toes, avoid squeezing, and wear comfortably
- Soft against the skin, fit the toes, shock absorption and compression, comfortable material
- Silicone material, easy to wear, not easy to slide after wearing, and not move when walking
- Flexible and resilient, not easy to deform, full of elasticity, not tiring feet when walking, no binding feeling
- Scope of application: hallux valgus, toe overlap, long-term wearing high heels and recommended by foot health care personnel
- 有效分離腳趾, 避免擠壓, 佩戴舒適
- 柔軟親膚, 貼合腳趾, 減震緩壓, 舒適材質
- 矽膠材質, 便於穿戴, 穿戴後不易滑落, 行走時不位移
- 柔韌回彈, 不易變形, 彈性十足, 走路不累腳, 無束縛感
- 適用範圍: 拇外翻、腳趾重疊、長期穿著高跟鞋及足部保健人士推薦使用



Specifications

| | |
|-----------------------|------------------------------------|
| Product model 產品型號 | JDQ |
| Product function 產品功能 | toe correction 腳趾矯正 |
| Product material 產品材質 | silicone 矽膠 |
| Color 顏色 | white 白色 |
| Specification 規格 | all sizes can be adjusted 均碼可調節 |
| Suitable for 適用於 | adult 成人 |
| Product size 產品尺寸 | 8.5*3*1cm |
| Product weight 產品重量 | 25g |
| Packing size 包裝尺寸 | 10*10*3cm |
| Package weight 包裝重量 | 0.05kg |



注意事項:

- ◆ 如使用後皮膚出現過敏請立即停止使用並尋求醫生診治
- ◆ 請遠離尖銳物品, 以免損壞產品
- ◆ 產品和家用清洗劑清洗

Thumb Valgus Corrector

腳拇指外翻矯正器

Model: JDZ

Features:

- The side aluminum strip/binding tape is fixed by magic, durable, user-friendly setting, and improves comfort
- Firmly bandaged velcro, firm, durable and repeatedly pasted
- Blue honeycomb breathable fabric, lined with high-quality breathable fabric, has fine touch, good flexibility and elasticity, and is not easy to wear tight frequently, comfortable experience
- 側面鋁條/綁帶魔術貼固定, 堅固耐用, 人性化設置, 提升舒適度
- 牢固綁帶魔術貼, 粘貼緊致牢固耐用反復粘貼
- 藍色蜂窩式透氣面料, 內襯高質量透氣面料, 觸感細膩, 柔軟性彈性俱佳, 佩帶不易緊繃勒, 舒適體驗



Specifications

| | |
|-----------------------|------------------------------|
| Product model 產品型號 | JDZ |
| Product function 產品功能 | toe fixed support 腳趾固定支撐 |
| Product material 產品材質 | composite fabric 複合面料 |
| Specifications 規格 | M (26-30 yards) M(26-30碼) |
| Color 顏色 | blue 藍色 |
| Product size 產品尺寸 | 24*10cm |
| Product weight 產品重量 | 16g |
| Packing size 包裝尺寸 | 10*10*3cm |
| Package weight 包裝重量 | 0.04kg |

注意事項:

- ◆ 根據自己的需求調節所需大小, 魔術貼粘接上即可。
- ◆ 此產品為腳趾保護指套, 請確保使用前諮詢醫師或相關醫護人員。
- ◆ 請正確使用該產品, 避免因不當使用造成意外傷害。

Night Hallux Valgus Appliance

夜用拇趾外翻矯正器

Model: JEW

Features:

- The appliance is fixed with velcro, which is easy to operate, easy to wash and durable
 - Use the elasticity of the fabric to pull the big toe, and the support angle of the PC bracket is stable
 - The fabric of the strap is elastic, firm, gentle and does not irritate the skin
- 採用魔术貼來固定矯正器,魔术貼操作方便簡單快捷,易洗耐用
 - 利用面料的彈力性能牽引大腳趾,PC支架支撐角度穩定
 - 固定帶面料富有彈性,服帖穩固,溫和不刺激皮膚



Specifications

| | |
|-----------------------|-------------------------------------|
| Product model 產品型號 | JEW |
| Product function 產品功能 | toe correction 腳趾矯正 |
| Product material 產品材質 | PVC, PU leather, EVA PVC,PU皮,EVA |
| Color 顏色 | blue+white 藍色+白色 |
| Specification 規格 | all sizes can be adjusted 均碼可調節 |
| Suitable for 適用於 | adult 成人 |
| Product size 產品尺寸 | 13*5*5cm |
| Product weight 產品重量 | 38g |
| Packing size 包裝尺寸 | 15*15*5cm |
| Package weight 包裝重量 | 0.09kg |



注意事項:

- ◆ 請勿使用金屬清潔球等尖銳物品進行清洗;
- ◆ 使用後請及時洗淨晾乾;
- ◆ 請勿長期置於高溫場所, 以免變形;

Flat Foot Arch Pad

扁平足足弓墊

Model: JDN

Features:

- Bandage design: elastic, sweat-absorbing, comfortable to walk, close to the arch, very stressed, shock absorption and pressure relief
- Soft and elastic, stretch without deformation, durable and comfortable package
- Double-layer elastic locking, supporting arch, comfortable and stable, fitting foot shape, can be worn in socks
- Scope of application: all kinds of people, sports people, foot arch depression, flat feet, plantar pain, etc.
- 繃帶設計: 彈力吸汗, 舒適行走, 貼合足弓, 均很受力, 減震緩壓
- 柔軟彈性十足, 拉伸不變形, 持久耐用, 舒適包裹
- 雙層彈力鎖邊, 支撐足弓受力舒適穩固, 貼合腳型, 可穿在襪子裏
- 適用範圍: 各類人群、運動人士、足弓場陷、扁平足、足底疼痛等。



Specifications

| | |
|-----------------------|--|
| Product model 產品型號 | JDN |
| Product function 產品功能 | toe fixed support 腳趾固定支撐 |
| Product material 產品材質 | high elastic bandage+silicone 高彈繃帶+矽膠 |
| Specifications 規格 | M (26-30 yards) M(26-30碼) |
| Color 顏色 | complexion 膚色 |
| Product size 產品尺寸 | 11*8cm |
| Product weight 產品重量 | 53g |
| Packing size 包裝尺寸 | 10*10*3cm |
| Package weight 包裝重量 | 0.07kg |



注意事項:

- ◆ 請勿使用金屬清潔球等尖銳物品進行清洗;
- ◆ 使用後請及時洗淨晾乾;
- ◆ 請勿長期置於高溫場所, 以免變形;

Breathable Non-slip Forefoot Pad

透氣防滑前掌墊

Model: JDO

Features:

- The bionic honeycomb vent design is skin friendly and breathable, and the sole is breathable and not sticky.
- Elastic soft silicone gel can disperse the force on the forefoot, relieve the pressure, and do not tighten the foot
- Flexible and resilient, not easy to deform, full of elasticity, not tiring feet when walking, no binding feeling



- 仿生蜂巢透氣孔設計, 親膚透氣, 足底透氣不黏膩
- 彈力軟矽膠, 分散前腳掌受力, 緩解壓力, 不勒腳
- 柔韌回彈, 不易變形, 彈性十足, 走路不累腳, 無束縛感

Specifications

| | |
|-----------------------|------------------------------------|
| Product model 產品型號 | JDO |
| Product function 產品功能 | toe correction 腳趾矯正 |
| Product material 產品材質 | silicone 矽膠 |
| Color 顏色 | white 白色 |
| Specification 規格 | all sizes can be adjusted 均碼可調節 |
| Suitable for 適用於 | adult 成人 |
| Product size 產品尺寸 | 7.5*6cm |
| Product weight 產品重量 | 20g |
| Packing size 包裝尺寸 | 10*10*3cm |
| Package weight 包裝重量 | 0.04kg |

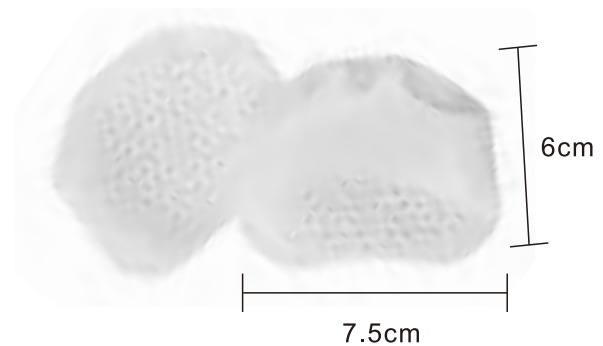

注意事項:

- ◆如使用後皮膚出現過敏請立即停止使用並尋求醫生診治
- ◆請遠離尖銳物品, 以免損壞產品
- ◆產品和家用清洗劑清洗

Arch Support Insole

足弓支撐鞋墊

Model: JEG

Features:

- Honeycomb design, three-dimensional shock absorption, strong support, effective shock absorption and cushioning
- U-shaped design, fit the heel and do not twist the foot
- Environmentally friendly raw materials, comfortable and soft, with good resilience



- 蜂窩設計, 立體減震, 強力支撐, 有效減震緩衝
- U型設計, 貼合腳跟, 不崧腳
- 環保原料, 舒適柔軟, 回彈性好

Specifications

| | |
|-----------------------|----------------------|
| Product model 產品型號 | JEG |
| Product function 產品功能 | arch support 足弓支撐 |
| Product material 產品材質 | TPR |
| Specification 規格 | M |
| Color 顏色 | complexion 膚色 |
| Product size 產品尺寸 | 15.6*6.4*2cm |
| Product weight 產品重量 | 96g |
| Packing size 包裝尺寸 | 15*15*5cm |
| Package weight 包裝重量 | 0.15kg |

注意事項:

- ◆ 請勿使用金屬清潔球等尖銳物品進行清洗;
- ◆ 使用後請及時洗淨晾乾;
- ◆ 請勿長期置於高溫場所, 以免變形;

Temperature Gear

氣壓式拇指外翻矯正器

Model: JFL

Features:

- Dynamic pressure and pressure increase, blood circulation is smooth, and toes are not cold
 - Multiple air columns are fixed, strong and visible, and wear firmly
 - Fits the foot shape, comfortable to wear without deformation
 - Skin-friendly suede for comfort
 - Press inflating balloon to adjust the inflating force at any time
- 動態增減壓, 血液迴圈暢通, 腳趾不涼
 - 多條氣柱固定, 有力有形, 佩戴穩固
 - 貼合腳型, 穿戴舒適不變形
 - 親膚絨面, 貼身舒服
 - 按壓式充氣球, 隨時調整充氣力度



Specifications

| | |
|-----------------------|--------------------------------------|
| Product model 產品型號 | JFL |
| Product function 產品功能 | correction of thumb valgus 拇指外翻矯正 |
| Product material 產品材質 | OK cloth diving material OK布潛水料 |
| Specification 規格 | for left and right feet 左右腳通用 |
| Inflation pipe 充氣管道 | 29cm |
| Extension belt 延長帶 | 16*2cm |
| Unfold size 展開尺寸 | 27*18cm |
| Product weight 產品重量 | 220g |
| Package size 包裝尺寸 | 22*18.5*11cm |
| Package weight 包裝重量 | 0.25kg |



注意事項:

- ◆ 螺釘安裝需將支撐板對準螺孔安裝螺釘旋鈕, 旋轉至不動為止。
- ◆ 此產品為踝關節護具, 請確保使用前諮詢醫師或相關醫護人員。
- ◆ 請正確使用該產品, 避免因不當使用造成意外傷害。

Dance Toe Guard

舞蹈護腳足尖套

Model: JDP

Features:

- Prevent toes from rubbing feet, pushing feet, and dancing to prevent pain and comfort
- Fits the foot shape design, relieves the pressure of the forefoot, and is comfortable without friction.
- Special fabric gel, with good stability and elasticity, breathable material, does not cause pain in toes
- Lightweight fabric, breathable holes can sweat well and avoid stuffiness
- Wearing is not easy to deform, and can be washed and reused
- Scope of application: dancing and caring for the health care personnel of the forefoot and foot
- 防止足尖磨腳、足尖頂腳、跳舞防痛舒適,保護舞者的雙足
- 貼合腳型設計,緩解前腳掌壓力,舒適五趾不摩擦。
- 特製布料凝膠,具有良好的穩定性和彈力性透氣材料,柔軟舒適不讓腳趾產生疼痛感
- 輕薄面料,細小的透氣孔能很好的排汗,避免悶濕
- 穿戴不易變形,可水洗反復使用
- 適用範圍:跳舞及護理前掌足部保健人士推薦使用

Specifications

| | |
|-----------------------|---|
| Product model 產品型號 | JDP |
| Product function 產品功能 | toe fixed support 腳趾固定支撐 |
| Product material 產品材質 | special fabric+special gel 特製布料+特製凝膠 |
| Specifications 規格 | one size fits all 均碼 |
| Product size 產品尺寸 | 9.5*10cm |
| Product weight 產品重量 | 42g |
| Packing size 包裝尺寸 | 10*10*3cm |
| Package weight 包裝重量 | 0.06kg |

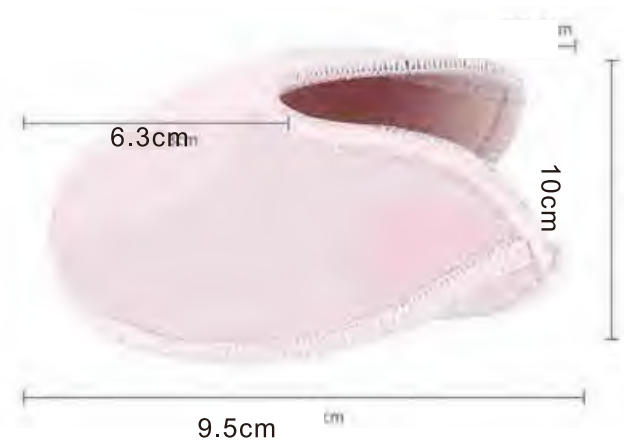

注意事項:

- ◆ 如使用後皮膚出現過敏請立即停止使用並尋求醫生診治
- ◆ 請遠離尖銳物品,以免損壞產品
- ◆ 產品和家用清洗劑清洗

Adjustable Foot Rest

可調節足部防護托 **Model: JAH**

Features:

- It can protect the ankle
- Artificial curve design, strengthen fixation, double protection
- Adjustable tightness, left and right universal, adjustable sliding button, easy to wear
- Lightweight fabric, comfortable and breathable
- Suitable for: plantar fasciitis stretching, dorsum of foot sprain and postoperative recovery, prevention of foot drop
- 可以保護腳踝
- 人工學曲線設計, 加強固定, 雙重保護
- 鬆緊可調, 左右通用, 可調節滑扣, 穿戴方便
- 輕薄面料, 舒適透氣
- 適用於: 足底筋膜炎拉伸, 足背拉傷扭傷及術後恢復, 預防足下垂



Specifications

| | |
|-----------------------|--|
| Product model 產品型號 | JAH |
| Product function 產品功能 | ankle fixation protection 腳踝固定保護 |
| Material 材質 | aluminum alloy strip, nylon strap, breathable ok fabric 鋁合金條、尼龍綁帶、透氣ok布料 |
| Suitable for 適用於 | feet 腳部 |
| Product size 產品尺寸 | 29*14*3cm |
| Product weight 產品重量 | 100 g |
| Packing size 包裝尺寸 | 25.5*20*7cm |
| Package weight 包裝重量 | 0.22kg |



注意事項:

- ◆ 根據自己的需求調節所需大小, 魔術貼粘接上即可。
- ◆ 此產品為踝關節護具, 請確保使用前諮詢醫師或相關醫護人員。
- ◆ 請正確使用該產品, 避免因不當使用造成意外傷害。

Inflatable Foot Protector

充氣型足部防護托 **Model: JAL**

Features:

- Inflatable ankle fixed, thick sponge lining, ankle splint, inflatable bladder lining, bilateral airbags, free adjustment
- Velcro, easy to fix, adjustable elasticity
- Suitable for: ankle sprain, foot correction, etc.
- 充氣型腳腕固定，加厚海綿內裡，足踝夾板，充氣囊內裡，雙側氣囊，自由調節
- 魔術貼，輕鬆固定，鬆緊可調
- 適用於：踝關節扭傷、腳部矯正等



Specifications

| | |
|-------------------------------------|---|
| Product model 產品型號 | JAL |
| Product function 產品功能 | ankle fixed support 腳腕固定支撐 |
| Product material 產品材質 | aluminum alloy strip, nylon strap, breathable ok fabric 鋁合金條、尼龍綁帶、透氣ok布料 |
| Specifications 規格 | free size, right and left be in common use 均碼,左右通用 |
| Color 顏色 | gray 灰色 |
| Part of use 使用部位 | ankle fixed 腳踝固定 |
| Adjustable length of calf 小腿部位可調節長度 | 35cm |
| Packing size 包裝尺寸 | 25.5*20*7cm |
| Package weight 包裝重量 | 0.32kg |



注意事項:

- ◆ 將受傷的腳放入產品中，然後根據自己的需求選擇充氣的多少。
- ◆ 此產品為踝關節護具，請確保使用前諮詢醫師或相關醫護人員。
- ◆ 請正確使用該產品，避免因不當使用造成意外傷害。

Foot Drop Soft Foot Support

垂足軟足托

Model: JAY

Features:

- The material is breathable and soft, which can be worn in shoes, beautiful and comfortable
- By adjusting the length of the cross buckle, a variety of treatments can be realized. It can be used during the day and night to protect the ankle
- Artificial curve design, strengthen fixation, double protection
- Adjustable tightness, universal left and right, adjustable sliding buckle, easy to wear
- 材質透氣、柔軟，可穿在鞋內，美觀舒適
- 通過調節交叉扣帶長度，實現多種治療
- 白天夜間均可使用，保護腳踝
- 人工學曲線設計，加強固定，雙重保護
- 鬆緊可調，左右通用，可調節滑扣，穿戴方便



Specifications

| | |
|-----------------------|---|
| Product model 產品型號 | JAY |
| Product function 產品功能 | ankle injury fixation support 腳踝受傷固定支撐 |
| Product material 產品材質 | 14% nylon 85% polyester 14%尼龍85%滌綸 |
| Fitting 貼合物 | 100% polyurethane 100%聚氨酯 |
| Specification 規格 | adjustable one size fits all 均碼可調節 |
| Suitable for 適用於 | for left and right feet 左右腳通用 |
| Color 顏色 | black 黑色 |
| Product weight 產品重量 | 73g |
| Packing size 包裝尺寸 | 12*12*5cm |
| Package weight 包裝重量 | 0.10kg |

注意事項:

- ◆ 將踝關節、足部的綁帶固定後將足部、足踝部彈力帶固定即可。
- ◆ 此產品為踝關節護具，請確保使用前諮詢醫師或相關醫護人員。
- ◆ 請正確使用該產品，避免因不當使用造成意外傷害。



適用於:

1. 矯正無力的足下垂(如:外傷、壓迫、鉛中毒、糖尿病等皆可導致腓總神經麻痺,引起足下垂)
2. 對抗輕度的肌張力增高導致的足下垂(如:中風、腦癱、腦外傷等)
3. 治療輕度的足內翻、足外翻,足底筋膜炎

Ankle Sprain Fixed Protective Cover

踝關節扭傷固定保護套

Model: KD

Features:

- Fixed and strengthened upgrades to prevent inversion and valgus, compression ankle support
- The fabric is breathable and soft, and can be worn in shoes, beautiful and comfortable
- The strong Velcro paste is more stable and more convenient to apply
- Applicable to: various sports such as running, fitness, playing ball, etc. and weak feet, sports strains, postoperative recovery, etc.
- 固定加強升級防止內翻外翻,加壓護踝
- 面料透氣、柔軟,可穿在鞋內,美觀舒適
- 強力魔術貼粘貼更穩固,適用更方便
- 適用於:跑步、健身、打球等各種運動與崙腳、運動拉傷、術後恢復等



Specifications

| | |
|-----------------------|---|
| Product model 產品型號 | KD |
| Product function 產品功能 | ankle injury fixation support 腳踝受傷固定支撐 |
| Product material 產品材質 | nylon 尼龍 |
| Specification 規格 | S (size 35-38) M (size 39-42) L (size 43-46) |
| Suitable for 適用於 | for left and right feet 左右腳通用 |
| Color 顏色 | black 黑色 |
| Product size 產品尺寸 | 22*14*7cm |
| Product weight 產品重量 | 150g |
| Packing size 包裝尺寸 | 25.5*20*7cm |
| Package weight 包裝重量 | 0.27kg |



注意事項:

- ◆ 將踝關節、足部的綁帶固定後將足部、足踝部彈力帶固定即可。
- ◆ 此產品為腳踝關節保護指套,請確保使用前諮詢醫師或相關醫護人員。
- ◆ 每次使用過後用溫和清洗劑洗滌,放於陰涼處自然風乾即可。

Ankle Fixed Foot Drop Brace

踝關節固定支具

Model: JBT

Features:

- Plastic buckle, strong durability, not easy to damage, easy and fast to use
- High density sponge is soft and comfortable, effectively preventing direct contact between sole and plastic parts
- The design of Velcro strap can be adjusted according to personal needs
- Detachable design, comfortable and breathable fabric, close fitting to the foot
- Applicable to: foot recovery, foot drop, etc
- 塑膠搭扣, 耐用性強, 不易損壞, 使用方便快捷
- 高密度海綿柔軟舒適, 有效防止腳底和塑膠件的直接接觸
- 魔术貼綁帶設計, 可根據個人需要進行調節
- 可拆卸式設計, 舒適透氣面料緊密貼合足部
- 適用於: 足部恢復、足下垂等



Specifications

| | |
|-----------------------|---|
| Product model 產品型號 | JBT |
| Product function 產品功能 | ankle injury fixation support 腳踝受傷固定支撐 |
| Product material 產品材質 | resin plastic board + sponge pad 樹脂塑膠板+海綿墊 |
| Specification 規格 | for left and right feet 左右腳通用 |
| Suitable size 適合尺碼 | 38-42碼 |
| Tube height 筒高 | 43.5cm |
| Bottom length 底長 | 28cm |
| Product weight 產品重量 | 520g |
| Package size 包裝尺寸 | 40*30*20cm |
| Package weight 包裝重量 | 1.00kg |



注意事項:

- ◆ 螺釘安裝需將支撐板對準螺孔安裝螺釘旋鈕, 旋轉至不動為止。
- ◆ 此產品為踝關節護具, 請確保使用前諮詢醫師或相關醫護人員。
- ◆ 請正確使用該產品, 避免因不當使用造成意外傷害。

Decompression And Pain Relief Heel Pad

減壓緩痛足跟腳墊

Model: JEX

Features:

- The wool feels flat, not easy to fluff and has good air permeability
- Easy to use, adjust the tightness at any time
- Lightweight breathable sponge composite cloth, long service life, replacement and cleaning anytime and anywhere

- 毛感平整, 不易起毛且透氣性好
- 使用方便, 隨時調節鬆緊度
- 採用輕薄透氣海綿複合布, 使用壽命長, 隨時隨地替換清潔



Specifications

| | |
|-----------------------|---|
| Product model 產品型號 | JEX |
| Product function 產品功能 | heel decompression 足跟減壓 |
| Product material 產品材質 | sponge composite+SBR+SEBS pad 海綿複合+SBR+SEBS墊 |
| Specification 規格 | L |
| Product size 產品尺寸 | 10.5*10.5*4.5cm |
| Product weight 產品重量 | 55g |
| Package size 包裝尺寸 | 12*12*5cm |
| Package weight 包裝重量 | 0.09kg |



注意事項:

- ◆ 請勿使用金屬清潔球等尖銳物品進行清洗;
- ◆ 使用後請及時洗淨晾乾;
- ◆ 請勿長期置於高溫場所, 以免變形;

Electric Heating And Moxibustion For Ankle Protection

電加熱艾炙護足踝

Model: JFG

Features:

- Selected fabrics, cold-proof, warm, durable and not easy to pilling
 - Strong magic hook, strong adhesion and long service life
 - It is equipped with a moxa bag mesh pocket, which can be put into the moxa bag for hot compress, which is convenient to use
- 精選面料, 防寒保暖結實耐用, 不易起球
 - 強力魔術勾, 粘貼性強, 使用壽命長
 - 內設艾絨包網兜, 放入艾絨包熱敷, 使用方便



Specifications

| | |
|-----------------------|----------------------------------|
| Product model 產品型號 | JFG |
| Product function 產品功能 | ankle hot compress 腳踝熱敷 |
| Product material 產品材質 | Ok cloth+carbon fiber Ok布+炭纖維 |
| Specification 規格 | one size fits all 均碼 |
| Color 顏色 | black 黑色 |
| Rated voltage 額定電壓 | 5V |
| Temperature gear 溫度檔位 | 65°C/55°C/45°C |
| Product size 產品尺寸 | 9.5*13*36.5cm |
| Product weight 產品重量 | 106g |
| Packing size 包裝尺寸 | 12*12*5cm |
| Package weight 包裝重量 | 0.13kg |



注意事項:

- ◆ 請勿使用金屬清潔球等尖銳物品進行清洗;
- ◆ 使用後請及時洗淨晾乾;
- ◆ 請勿長期置於高溫場所, 以免變形;



Ziglite Smart Health Care Products Co., Ltd.
節亮康護產品有限公司

Hong Kong Office Address

Room B3, 18/F Bonsun Industrial Building, 364-366 Sha Tsui Road, Tsuen Wan, Hong Kong

Office Hour : Mon - Fri : 9:30 - 5:30pm

Email : info@ziglite.com

Office : +852 3107 7500

Fax: +852 3544 0462

Whatsapp : +852 6827 2010



www.ziglite.com

